

DOSS

Bluetooth®

Wireless Portable Bluetooth Speaker



Mode No.: SoundBox
User Manual

introduction

Thank you for purchasing the **DOSS SoundBox Wireless Portable Bluetooth Speaker** with Bluetooth and Hands free function. We encourage you to read this instruction guide thoroughly to get the most out of this innovative wireless portable speaker.

Package content

- One wireless portable speaker
- USB charging cable
- Φ 3.5mm auxiliary cable
- Travel waterproof pouch
- User manual, Warranty card, Contact card

Product overview

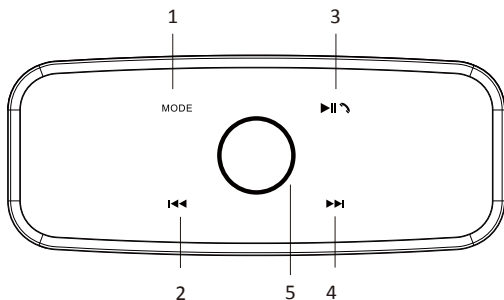

Backlit touch-sensitive buttons

1. **Mode switch:** Touch **MODE** to toggle play mode among Bluetooth, TF Card and Aux-in connection.
2. In Bluetooth mode/TF mode, touch **⏮** to skip backward.
3. **Play/Pause and handset button**
 - In Bluetooth mode, touch **📞** to answer or end a call. Touch for 3 seconds to reject a call.
 - In Bluetooth mode, touch **⏮** to play/pause your tune. Touch for 3 seconds to disconnect with your device.
 - In TF mode, touch **📞** to play/pause your tune.
4. In Bluetooth mode/TF mode, touch **⏭** to skip forward.
5. **Volume control:**
 - Clockwise rotation to increase the volume.
 - Counterclockwise rotation to decrease the volume.

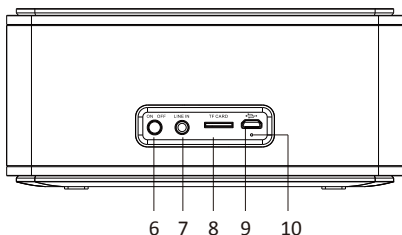

6. **Power button:** Long press  to turn the device on and off.
7. **Auxiliary $\Phi 3.5\text{mm}$ jack :** Use it for cabled playback with compatible devices.
8. **TF card:** Use it for TF card (with music) playback. support mp3,wav, songs,32G or smaller size cards are better,if not,pls format that to FAT32.
9. **Charging port:** Plug the supplied USB cable into this port to recharge the built-in battery.
10. **LED charging indicator.**
 - Charging : Steady Red.
 - Fully charged : Steady Green.

Status indicators



Center indicator/ ontrol button	Flashing blue	Indicates that the speaker has entered into the pairing mode and it is ready to be paired
	Steady blue	Indicates that the device is successfully paired
	Steady red	Indicates that the device has switched to the auxiliary input mode
	Steady Green	Indicates that the device has switched to the TF mode
Battery status indicator	Steady red	Battery is charging
	Steady green	Battery is fully charged

Preparation



- Use the supplied USB cable to charge your portable speaker directly from your computer or device with a micro USB port.
- Make sure that the speaker is fully charged before using it for the first time.
- Remember to note the above point and fully charge your speaker prior to the first use. It will take approximately 2-3 hours to recharge after.
- LED light will remain RED when charging and turn GREEN once charge completes.
- Press & Hold the power button to turn on the speaker. Repeat the steps to turn the device off as well.

Note: The speaker has a built-in battery saver mode where it will automatically power off if not in use for 15 minutes. This function can be removed with a firmware upgrade. For assistance, please contact: support@dossav.com

Pairing the wireless speaker with your smart device

1. Place your smart device and wireless speaker no more than one meter away from each other.
2. Press the power button located on the back of the speaker for several seconds to turn it on.
3. Set your smart device to “discover” the wireless speaker. Upon powering on, a tone will be heard, the blue LED will start flashing, accompanied by a prompt notifying that the speaker has entered into the pairing mode.
4. Enabled Bluetooth on your device and choose **DOSS SoundBox** from the list.
5. If pairing is successful, the LED will change to steady blue and your phone will confirm that the connection has been established. If the pairing process fails after 60 seconds, please repeat steps 1 through 5 described above.
6. long press the button  , you can disconnect the Bluetooth.
Note: If your smart device cannot discover the SoundBox, long press the button  and have a try again.

Answering and ending a call using your speaker or mobile phone

1. When there is an incoming call, the speaker will generate a tone and a verbal notification to alert you of this event.
2. Briefly press the Handset  button to pick up, long press to reject. You may also press the answer button on your smart phone to take the call using the speaker.
3. Speak with a clear voice right into the built-in microphone located on the front section of the speaker.
4. To end a call, tap the Handset  button once again. Likewise, you may also end the call directly using the command on your cell phone.
5. When listening to music using your smart phone, playback will resume automatically once the call has ended.

Using it with your Echo Dot

You can connect the Dot with the speaker using a 3.5 mm auxin cable or Bluetooth. Please use the following steps to set up using Bluetooth:

1. Download the Alexa APP, follow the standard setup procedure to get the dot connected to your home Wi-Fi network.
2. Switch the SoundBox speaker to Bluetooth mode, you can press the 'play/handsfree' button for 5 seconds to keep it in pairing status.
3. Run the Alexa app, tap Menu and then tap Settings.
4. Tap the Echo Dot in your list of Alexa Devices, then tap Bluetooth.
5. The SoundBox speaker should appear in the list of Bluetooth Devices. If not, press the "play/hands-free" button for 5 seconds and try again. Once listed, tap on The SoundBox speaker to complete the pairing process. To remove the device, return to Bluetooth -> tap the name of the speaker -> then tap "Forget Device".

Note:

1. Voice command will not be able to turn on/off the Soundbox no matter whether you connect it via Bluetooth / Aux cable. It can only translate sound signal.
2. To remove the battery saver option, please contact our customer service at support@dossav.com to remove the function by upgrading the firmware.

	Problem	Solution
Bluetooth	Cannot Pair with Bluetooth devices	Press Play/Pause button for 5 seconds,then have a try to pair it again
	Cannot play music after pairing	Please select 'DOSS SoundBox' as the default playback device
	The song cuts off during playback	Please check if the Bluetooth distance is more than 33 feet or the battery level is low
	There is noise during playback	Maybe caused by the interference of charging,try to put it in another place and do not charge it during playback
	Laptop prompts to install driver	This driver is not special for SoundBox,it's for your laptop Bluetooth function,please contact the computer company or windows
	Not paired with transmitter	Please press Play/ Pause button for 5 seconds or contact with the transmitter's customer service for help
TF Card	The speaker do not play when the card is inserted,and jump directly back to Bluetooth mode	Check whether the card format is FAT or FAT32. If not, format it to FAT or FAT32. Check the song format. The speaker only supports MP3, WAV
	The song cuts off during playback	There may be a problem with the song's file, try deleting all the songs in the same file
other	All the lights are lit and can not be turned off	Use the needle or wire to poke the reset button inside Auxin
	Customer Service Email	support@dossav.com

Product specifications

Product type: Wireless Portable Bluetooth Speaker with Built-in Microphone

Output power: 6W x 2

Driver unit: 1.5 inch speaker x 2 + 2.6 inch passive radiator

Frequency response: 100Hz-18kHz

Signal to noise ratio: ≤ 55 dB

Unit weight: 560 g

Unit dimension: 6.6 x 2.7 x 2.9 inch

Warranty: One-year limited

Power

- Battery type: Li-ion 3.7V, 2200mAh
- Input: 5V \equiv 1A
- Battery charge up time: 3 hours approximately (when fully depleted).
- Battery playback time: up to 12 hours (duration time may vary depending on the volume level used and usage patterns).

Wireless/Networking

- Bluetooth specification: V4.0+EDR, backwards compatible with previous Bluetooth versions
- Profiles supported
- A2DP (Advanced Audio Distribution Profile)
- Maximum operation range: 10 meters / 33 ft

Warning

- Do NOT drop, hit or shake the device.
- Do NOT disassemble, repair or modify the Bluetooth speaker by yourself.
- Do NOT use cleaning products that contain benzene, solvents or alcohol.
- Do NOT expose the Bluetooth speaker to excessive heat or to direct sunlight for long periods of time.
- Do NOT store the device in a place with high humidity or dust.
- Do NOT place heavy objects on top of the Bluetooth speaker.
- Do NOT use near a microwave oven or wireless LAN products.



Scan this or search 'DOSS fans' on Facebook to join our group, share your experience and find more surprise!

DOSS

Wonders Technology Co., Ltd

Email: Support@dossav.com

Follow us on Facebook:

<https://www.facebook.com/dossav>