

**ThinkPad**

# User Guide

ThinkPad X230 and X230i

**Notes:** Before using this information and the product it supports, be sure to read and understand the following:

- *Safety, Warranty, and Setup Guide*
- *Regulatory Notice*
- “Important safety information” on page vi
- Appendix D “Notices” on page 163

The *Safety, Warranty, and Setup Guide* and the *Regulatory Notice* have been uploaded to the Web site. To refer to them, go to <http://www.lenovo.com/ThinkPadUserGuides>.

**Second Edition (May 2012)**

© Copyright Lenovo 2012.

LIMITED AND RESTRICTED RIGHTS NOTICE: If data or software is delivered pursuant a General Services Administration “GSA” contract, use, reproduction, or disclosure is subject to restrictions set forth in Contract No. GS-35F-05925.

---

# Contents

<b>Read this first</b> . . . . .	<b>v</b>	Connecting to the network . . . . .	32
Important safety information . . . . .	vi	Ethernet connections . . . . .	32
Conditions that require immediate action . . . . .	vii	Wireless connections . . . . .	32
Safety guidelines . . . . .	vii	Presentations and multimedia . . . . .	36
		Changing display settings . . . . .	36
<b>Chapter 1. Product overview</b> . . . . .	<b>1</b>	Connecting a projector or external display . . . . .	36
Locating computer controls, connectors, and indicators . . . . .	1	Setting up a presentation . . . . .	39
Front view . . . . .	1	Using the Extend desktop function . . . . .	39
Right-side view . . . . .	3	Using audio features . . . . .	40
Left-side view . . . . .	5	Using the integrated camera . . . . .	40
Bottom view . . . . .	6	Using an ExpressCard, a flash media card, or a smart card . . . . .	41
Rear view . . . . .	7		
Status indicators . . . . .	7	<b>Chapter 3. You and your computer</b> . . . . .	<b>45</b>
Locating important product information . . . . .	9	Accessibility and comfort . . . . .	45
Machine type and model label . . . . .	9	Ergonomic information . . . . .	45
FCC ID and IC Certification number label . . . . .	10	Comfort . . . . .	46
Certificate of Authenticity label . . . . .	10	Accessibility information . . . . .	46
Features . . . . .	11	Traveling with your computer . . . . .	47
Specifications . . . . .	12	Travel tips . . . . .	47
Operating environment . . . . .	13	Travel accessories . . . . .	48
ThinkVantage Technologies and software . . . . .	13		
Accessing ThinkVantage applications on the Windows 7 operating system . . . . .	13	<b>Chapter 4. Security</b> . . . . .	<b>49</b>
ThinkVantage applications . . . . .	15	Attaching a mechanical lock . . . . .	49
		Using passwords . . . . .	49
<b>Chapter 2. Using your computer</b> . . . . .	<b>19</b>	Passwords and sleep mode . . . . .	49
Registering your computer . . . . .	19	Typing passwords . . . . .	49
Frequently asked questions . . . . .	19	Power-on password . . . . .	50
Special keys and buttons . . . . .	20	Hard disk passwords . . . . .	50
Function key combinations . . . . .	20	Supervisor password . . . . .	52
Volume and mute buttons . . . . .	23	Hard disk security . . . . .	54
Windows key . . . . .	24	Setting the security chip . . . . .	55
Using the UltraNav pointing device . . . . .	24	Using the fingerprint reader . . . . .	56
Using the TrackPoint pointing device . . . . .	25	Notice on deleting data from your hard disk drive or solid state drive . . . . .	59
Using the touch pad . . . . .	26	Using firewalls . . . . .	60
Behavior of the UltraNav and an external mouse . . . . .	27	Protecting data against viruses . . . . .	60
Adding the UltraNav icon to the system tray . . . . .	27		
Power management . . . . .	28	<b>Chapter 5. Recovery overview</b> . . . . .	<b>61</b>
Checking battery status . . . . .	28	Creating and using recovery media . . . . .	61
Using the ac power adapter . . . . .	28	Performing backup and recovery operations . . . . .	62
Charging the battery . . . . .	29	Using the Rescue and Recovery workspace . . . . .	63
Maximizing battery life . . . . .	29	Creating and using a rescue medium . . . . .	64
Managing your battery power . . . . .	29	Reinstalling preinstalled applications and device drivers . . . . .	65
Power-saving modes . . . . .	29	Solving recovery problems . . . . .	66
Handling the battery . . . . .	30		
		<b>Chapter 6. Replacing devices</b> . . . . .	<b>67</b>

Static electricity prevention . . . . .	67
Replacing the battery . . . . .	67
Replacing the SIM card . . . . .	70
Replacing the hard disk drive or solid state drive . . . . .	71
Replacing a memory module . . . . .	73
Replacing the keyboard . . . . .	76
Replacing the palm rest . . . . .	79
Replacing the speaker. . . . .	83
Replacing the backup battery . . . . .	84

**Chapter 7. Enhancing your computer . . . . . 87**

Finding ThinkPad options . . . . .	87
ThinkPad Battery 19+ . . . . .	87
ThinkPad UltraBase Series 3 . . . . .	90
Top view . . . . .	91
Bottom view . . . . .	92
Attaching the ThinkPad UltraBase Series 3 . . . . .	92
Detaching the ThinkPad UltraBase Series 3 . . . . .	94
Security feature . . . . .	95
Other ThinkPad port replicators and docking stations . . . . .	96
Front view. . . . .	97
Rear view . . . . .	99
Attaching a ThinkPad port replicator or docking station. . . . .	101
Detaching a ThinkPad port replicator or docking station. . . . .	103
Security feature . . . . .	104
Using the system lock key . . . . .	104

**Chapter 8. Advanced configuration . . . . . 105**

Installing a new operating system . . . . .	105
Before you begin . . . . .	105
Installing the Windows 7 operating system . . . . .	106
Installing device drivers . . . . .	107
ThinkPad Setup . . . . .	108
Main menu . . . . .	108
Config menu. . . . .	109
Date/Time menu . . . . .	115
Security menu . . . . .	115
Startup menu . . . . .	119
Restart menu . . . . .	121
Updating your system UEFI BIOS . . . . .	121
Using system management. . . . .	121
System management . . . . .	122
Setting management features . . . . .	122

**Chapter 9. Preventing problems . . . . . 125**

General tips for preventing problems . . . . .	125
--	-----

Making sure device drivers are current . . . . .	126
Taking care of your computer . . . . .	127
Cleaning the cover of your computer . . . . .	128

**Chapter 10. Troubleshooting computer problems . . . . . 131**

Diagnosing problems . . . . .	131
Troubleshooting . . . . .	131
Computer stops responding . . . . .	131
Spills on the keyboard . . . . .	132
Error messages . . . . .	132
Errors without messages . . . . .	134
Beep errors . . . . .	135
Memory module problems . . . . .	135
Networking problems . . . . .	135
Problems with the keyboard and other pointing devices. . . . .	137
Problems with the display and multimedia devices. . . . .	138
Fingerprint reader problems. . . . .	141
Battery and power problems . . . . .	142
Problems with drives and other storage devices. . . . .	145
A software problem . . . . .	145
Problems with ports and connectors . . . . .	146
A USB problem . . . . .	146
A docking station or port replicator problem . . . . .	146

**Chapter 11. Getting support . . . . . 147**

Before you contact Lenovo . . . . .	147
Getting help and service . . . . .	147
Using diagnostic programs . . . . .	148
Lenovo support Web site. . . . .	148
Calling Lenovo . . . . .	148
Purchasing additional services . . . . .	149

**Appendix A. Regulatory Information . . . . . 151**

Wireless related information . . . . .	151
Location of the UltraConnect™ wireless antennas . . . . .	152
Locating wireless regulatory notices . . . . .	153
Export classification notice . . . . .	153
Electronic emission notices. . . . .	153
Federal Communications Commission Declaration of Conformity . . . . .	153
Industry Canada Class B emission compliance statement . . . . .	154
European Union - Compliance to the Electromagnetic Compatibility Directive . . . . .	154
German Class B compliance statement . . . . .	154
Korea Class B compliance statement . . . . .	155

---

Japan VCCI Class B compliance statement . . . . .	155	Battery recycling information for Taiwan . . . . .	158
Japan compliance statement for products which connect to the power mains with rated current less than or equal to 20 A per phase . . . . .	155	Battery recycling information for the European Union . . . . .	159
Lenovo product service information for Taiwan . . . . .	155	Battery recycling information for the United States and Canada . . . . .	159
<b>Appendix B. WEEE and recycling statements . . . . .</b>	<b>157</b>	<b>Appendix C. ENERGY STAR model information . . . . .</b>	<b>161</b>
EU WEEE statements . . . . .	157	<b>Appendix D. Notices. . . . .</b>	<b>163</b>
Japan recycling statements . . . . .	157	Trademarks . . . . .	164
Recycling information for Brazil . . . . .	158		



---

## Read this first

Be sure to follow the important tips given here to get the most use and enjoyment out of your computer. Failure to do so might lead to discomfort or injury, or cause your computer to fail.

### Protect yourself from the heat that your computer generates.



When your computer is turned on or the battery is charging, the base, the palm rest, and some other parts may become hot. The temperature they reach depends on the amount of system activity and the level of charge in the battery.

Extended contact with your body, even through clothing, could cause discomfort or even a skin burn.

- Avoid keeping your hands, your lap, or any other part of your body in contact with a hot section of the computer for any extended time.
- Periodically take hands from using the keyboard by lifting your hands from the palm rest.

### Protect yourself from the heat generated by the ac power adapter.



When the ac power adapter is connected to an electrical outlet and your computer, it generates heat.

Extended contact with your body, even through clothing, may cause a skin burn.

- Do not place the ac power adapter in contact with any part of your body while it is in use.
- Never use it to warm your body.

### Prevent your computer from getting wet.



To avoid spills and the danger of electrical shock, keep liquids away from your computer.

### Protect the cables from being damaged.

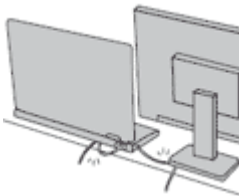

Applying strong force to cables may damage or break them.

Route communication lines, or the cables of an ac power adapter, a mouse, a keyboard, a printer, or any other electronic device, so that they cannot be walked on, tripped over, pinched by your computer or other objects, or in any way subjected to treatment that could interfere with the operation of your computer.

## Protect your computer and data when moving it.



Before moving a computer equipped with a hard disk drive, do one of the following, and make sure that the power button is off or is blinking:

- Turn it off.
- Put it in sleep mode.
- Put it in hibernation mode.

This will help to prevent damage to the computer, and possible loss of data.

## Handle your computer gently.



Do not drop, bump, scratch, twist, hit, vibrate, push, or place heavy objects on your computer, display, or external devices.

## Carry your computer carefully.



- Use a quality carrying case that provides adequate cushioning and protection.
- Do not pack your computer in a tightly packed suitcase or bag.
- Before putting your computer in a carrying case, make sure that it is off, in sleep mode, or in hibernation mode. Do not put a computer in a carrying case while it is turned on.

## Important safety information

**Note:** Read the important safety information first.

This information can help you safely use your notebook computer. Follow and retain all information included with your computer. The information in this document does not alter the terms of your purchase agreement or the Lenovo® Limited Warranty. For more information, see “Warranty Information” in the *Safety, Warranty, and Setup Guide* that comes with your computer.

Customer safety is important. Our products are developed to be safe and effective. However, personal computers are electronic devices. Power cords, power adapters, and other features can create potential safety risks that can result in physical injury or property damage, especially if misused. To reduce these risks, follow the instructions included with your product, observe all warnings on the product and in the operating instructions, and review the information included in this document carefully. By carefully following the information contained in this document and provided with your product, you can help protect yourself from hazards and create a safer computer work environment.

**Note:** This information includes references to power adapters and batteries. In addition to notebook computers, some products (such as speakers and monitors) ship with external power adapters. If you have such a product, this information applies to your product. In addition, computer products contain a coin-sized internal battery that provides power to the system clock even when the computer is unplugged, so the battery safety information applies to all computer products.



## Conditions that require immediate action

Products can become damaged due to misuse or neglect. Some product damage is serious enough that the product should not be used again until it has been inspected and, if necessary, repaired by an authorized servicer.

As with any electronic device, pay close attention to the product when it is turned on. On very rare occasions, you might notice an odor or see a puff of smoke or sparks vent from your product. Or you might hear sounds like popping, cracking or hissing. These conditions might merely mean that an internal electronic component has failed in a safe and controlled manner. Or, they might indicate a potential safety issue. However, do not take risks or attempt to diagnose the situation yourself. Contact the Customer Support Center for further guidance. For a list of Service and Support phone numbers, see the following Web site:

<http://www.lenovo.com/support/phone>

Frequently inspect your computer and its components for damage or wear or signs of danger. If you have any question about the condition of a component, do not use the product. Contact the Customer Support Center or the product manufacturer for instructions on how to inspect the product and have it repaired, if necessary.

In the unlikely event that you notice any of the following conditions, or if you have any safety concerns with your product, stop using the product and unplug it from the power source and telecommunication lines until you can speak to the Customer Support Center for further guidance.

- Power cords, plugs, power adapters, extension cords, surge protectors, or power supplies that are cracked, broken, or damaged.
- Signs of overheating, smoke, sparks, or fire.
- Damage to a battery (such as cracks, dents, or creases), discharge from a battery, or a buildup of foreign substances on the battery.
- A cracking, hissing or popping sound, or strong odor that comes from the product.
- Signs that liquid has been spilled or an object has fallen onto the computer product, the power cord or power adapter.
- The computer product, power cord, or power adapter has been exposed to water.
- The product has been dropped or damaged in any way.
- The product does not operate normally when you follow the operating instructions.

**Note:** If you notice these conditions with a product (such as an extension cord) that is not manufactured for or by Lenovo, stop using that product until you can contact the product manufacturer for further instructions, or until you get a suitable replacement.

## Safety guidelines

Always observe the following precautions to reduce the risk of injury and property damage.

### Service and upgrades

Do not attempt to service a product yourself unless instructed to do so by the Customer Support Center or your documentation. Only use a Service Provider who is approved to repair your particular product.

**Note:** Some computer parts can be upgraded or replaced by the customer. Upgrades typically are referred to as options. Replacement parts approved for customer installation are referred to as Customer Replaceable Units, or CRUs. Lenovo provides documentation with instructions when it is appropriate for customers to install options or replace CRUs. You must closely follow all instructions when installing or replacing parts. The Off state of a power indicator does not necessarily mean that voltage levels inside a

product are zero. Before you remove the covers from a product equipped with a power cord, always make sure that the power is turned off and that the product is unplugged from any power source. If you have any questions or concerns, contact the Customer Support Center.

Although there are no moving parts in your computer after the power cord has been disconnected, the following warnings are required for your safety.

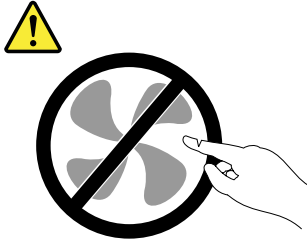

**CAUTION:**  
Hazardous moving parts. Keep fingers and other body parts away.

**CAUTION:**



**Before replacing any CRUs, turn off the computer and wait three to five minutes to let the computer cool before opening the cover.**

## Power cords and power adapters



**DANGER**

Use only the power cords and power adapters supplied by the product manufacturer.

The power cords shall be safety approved. For Germany, it shall be H05VV-F, 3G, 0.75 mm<sup>2</sup>, or better. For other countries, the suitable types shall be used accordingly.

Never wrap a power cord around a power adapter or other object. Doing so can stress the cord in ways that can cause the cord to fray, crack, or crimp. This can present a safety hazard.

Always route power cords so that they will not be walked on, tripped over, or pinched by objects.

Protect power cords and power adapters from liquids. For instance, do not leave your power cord or power adapter near sinks, tubs, toilets, or on floors that are cleaned with liquid cleansers. Liquids can cause a short circuit, particularly if the power cord or power adapter has been stressed by misuse. Liquids also can cause gradual corrosion of power cord terminals and/or the connector terminals on a power adapter, which can eventually result in overheating.

Always connect power cords and signal cables in the correct order and ensure that all power cord connectors are securely and completely plugged into receptacles.

Do not use any power adapter that shows corrosion at the ac input pins or shows signs of overheating (such as deformed plastic) at the ac input pins or anywhere on the power adapter.

Do not use any power cords where the electrical contacts on either end show signs of corrosion or overheating or where the power cord appears to have been damaged in any way.

To prevent possible overheating, do not cover the power adapter with clothing or other objects when the power adapter is plugged into an electrical outlet.

## Extension cords and related devices

Ensure that extension cords, surge protectors, uninterruptible power supplies, and power strips that you use are rated to handle the electrical requirements of the product. Never overload these devices. If power strips are used, the load should not exceed the power strip input rating. Consult an electrician for more information if you have questions about power loads, power requirements, and input ratings.

## Plugs and outlets



If a receptacle (power outlet) that you intend to use with your computer equipment appears to be damaged or corroded, do not use the outlet until it is replaced by a qualified electrician.

Do not bend or modify the plug. If the plug is damaged, contact the manufacturer to obtain a replacement.

Do not share an electrical outlet with other home or commercial appliances that draw large amounts of electricity; otherwise, unstable voltage might damage your computer, data, or attached devices.

Some products are equipped with a three-pronged plug. This plug fits only into a grounded electrical outlet. This is a safety feature. Do not defeat this safety feature by trying to insert it into a non-grounded outlet. If you cannot insert the plug into the outlet, contact an electrician for an approved outlet adapter or to replace the outlet with one that enables this safety feature. Never overload an electrical outlet. The overall system load should not exceed 80 percent of the branch circuit rating. Consult an electrician for more information if you have questions about power loads and branch circuit ratings.

Be sure that the power outlet you are using is properly wired, easily accessible, and located close to the equipment. Do not fully extend power cords in a way that will stress the cords.

Be sure that the power outlet provides the correct voltage and current for the product you are installing.

Carefully connect and disconnect the equipment from the electrical outlet.

## Power supply statement



Never remove the cover on a power supply or any part that has the following label attached.

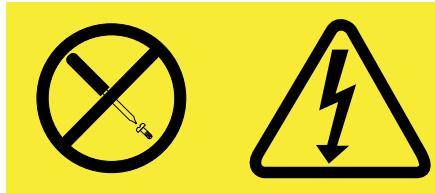

Hazardous voltage, current, and energy levels are present inside any component that has this label attached. There are no serviceable parts inside these components. If you suspect a problem with one of these parts, contact a service technician.

## External devices

### CAUTION:

Do not connect or disconnect any external device cables other than USB cables while the computer power is on; otherwise, you might damage your computer. To avoid possible damage to attached devices, wait at least five seconds after the computer is shut down to disconnect external devices.

## General battery notice



**DANGER**

Personal computers manufactured by Lenovo contain a coin cell battery to provide power to the system clock. In addition, many mobile products, such as notebook computers, utilize a rechargeable battery pack to provide system power when in portable mode. Batteries supplied by Lenovo for use with your product have been tested for compatibility and should only be replaced with approved parts.

Never attempt to open or service any battery. Do not crush, puncture, or incinerate batteries or short circuit the metal contacts. Do not expose the battery to water or other liquids. Only recharge the battery pack strictly according to instructions included in the product documentation.

Battery abuse or mishandling can cause the battery to overheat, which can cause gasses or flame to “vent” from the battery pack or coin cell. If your battery is damaged, or if you notice any discharge from your battery or the buildup of foreign materials on the battery leads, stop using the battery and obtain a replacement from the battery manufacturer.

Batteries can degrade when they are left unused for long periods of time. For some rechargeable batteries (particularly Lithium Ion batteries), leaving a battery unused in a discharged state could increase the risk of a battery short circuit, which could shorten the life of the battery and also can pose a safety hazard. Do not let rechargeable Lithium-Ion batteries completely discharge or store these batteries in a discharged state.

## Rechargeable battery notice



**DANGER**

Do not attempt to disassemble or modify the battery pack. Attempting to do so can cause an explosion, or liquid leakage from the battery pack. A battery pack other than the one specified by Lenovo, or a disassembled or modified battery pack is not covered by the warranty.

If the rechargeable battery pack is incorrectly replaced, there is danger of an explosion. The battery pack contains a small amount of harmful substances. To avoid possible injury:

- Replace only with a battery of the type recommended by Lenovo.
- Keep the battery pack away from fire.
- Do not expose it to water or rain.
- Do not attempt to disassemble it.
- Do not short-circuit it.
- Keep it away from children.
- Do not drop the battery pack.

Do not put the battery pack in trash that is disposed of in landfills. When disposing of the battery, comply with local ordinances or regulations.

The battery pack should be stored at room temperature, charged to approximately 30 to 50% of capacity. We recommend that battery pack be charged about once per year to prevent overdischarge.

## Lithium coin cell battery notice



**DANGER**

**Danger of explosion if battery is incorrectly replaced.**

**When replacing the lithium coin cell battery, use only the same or an equivalent type that is recommended by the manufacturer. The battery contains lithium and can explode if not properly used, handled, or disposed of.**

**Do not:**

- **Throw or immerse into water**
- **Heat to more than 100°C (212°F)**
- **Repair or disassemble**

**Dispose of the battery as required by local ordinances or regulations.**

**The following statement applies to users in the state of California, U.S.A.**

**California Perchlorate Information:**

**Products containing CR (manganese dioxide) lithium coin cell batteries may contain perchlorate.**

**Perchlorate Material - special handling may apply, See [www.dtsc.ca.gov/hazardouswaste/perchlorate](http://www.dtsc.ca.gov/hazardouswaste/perchlorate)**

## Heat and product ventilation



### DANGER

Computers, ac power adapters, and many accessories can generate heat when turned on and when batteries are charging. Notebook computers can generate a significant amount of heat due to their compact size. Always follow these basic precautions:

- When your computer is turned on or the battery is charging, the base, the palm rest, and some other parts may become hot. Avoid keeping your hands, your lap, or any other part of your body in contact with a hot section of the computer for any extended length of time. When you use the keyboard, avoid keeping your palms on the palm rest for a prolonged period of time. Your computer generates some heat during normal operation. The amount of heat depends on the amount of system activity and the battery charge level. Extended contact with your body, even through clothing, could cause discomfort or even a skin burn. Periodically take breaks from using the keyboard by lifting your hands from the palm rest; and be careful not to use the keyboard for any extended length of time.
- Do not operate your computer or charge the battery near flammable materials or in explosive environments.
- Ventilation slots, fans and/or heat sinks are provided with the product for safety, comfort, and reliable operation. These features might inadvertently become blocked by placing the product on a bed, sofa, carpet, or other flexible surface. Never block, cover, or disable these features.
- When the ac power adapter is connected to an electrical outlet and your computer, it generates heat. Do not place the adapter in contact with any part of your body while using it. Never use the ac power adapter to warm your body. Extended contact with your body, even through clothing, may cause a skin burn.

For your safety, always follow these basic precautions with your computer:

- Keep the cover closed whenever the computer is plugged in.
- Regularly inspect the outside of the computer for dust accumulation.
- Remove dust from vents and any perforations in the bezel. More frequent cleanings might be required for computers in dusty or high-traffic areas.
- Do not restrict or block any ventilation openings.
- Do not operate your computer inside furniture, as this might increase the risk of overheating.
- Airflow temperatures into the computer should not exceed 35°C (95°F).

## Electrical current safety information



### DANGER

Electric current from power, telephone, and communication cables is hazardous.

To avoid a shock hazard:

- Do not use your computer during a lightning storm.
- Do not connect or disconnect any cables or perform installation, maintenance, or reconfiguration of this product during an electrical storm.
- Connect all power cords to a properly wired and grounded electrical outlet.
- Connect to properly wired outlets any equipment that will be attached to this product.
- Whenever possible, use one hand only to connect or disconnect signal cables.
- Never turn on any equipment when there is evidence of fire, water, or structural damage.
- Disconnect the attached power cords, battery pack, and all the cables before you open the device covers, unless instructed otherwise in the installation and configuration procedures.
- Do not use you computer until all internal parts enclosures are fastened into place. Never use the computer when internal parts and circuits are exposed.



### DANGER

Connect and disconnect cables as described in the following procedures when installing, moving, or opening covers on this product or attached devices.

To connect:

1. Turn everything OFF.
2. First, attach all cables to devices.
3. Attach signal cables to connectors.
4. Attach power cords to outlets.
5. Turn devices ON.

To disconnect:

1. Turn everything OFF.
2. First, remove power cords from outlets.
3. Remove signal cables from connectors.
4. Remove all cables from devices.

The power cord must be disconnected from the wall outlet or receptacle before installing all other electrical cables connected to the computer.

The power cord may be reconnected to the wall outlet or receptacle only after all other electrical cables have been connected to the computer.

## Liquid crystal display (LCD) notice

### CAUTION:

The liquid crystal display (LCD) is made of glass, and rough handling or dropping the computer can cause the LCD to break. If the LCD breaks and the internal fluid gets into your eyes or on your hands, immediately wash the affected areas with water for at least 15 minutes; if any symptoms are present after washing, get medical care.

**Note:** For products with mercury-containing fluorescent lamps (for example, non-LED), the fluorescent lamp in the liquid crystal display (LCD) contains mercury; dispose of according to local, state, or federal laws.



## Using headphones or earphones

If your computer has both a headphone connector and an audio-out connector, always use the headphone connector for headphones (also called a headset) or earphones.

### CAUTION:

**Excessive sound pressure from earphones and headphones can cause hearing loss. Adjustment of the equalizer to maximum increases the earphone and headphone output voltage and the sound pressure level. Therefore, to protect your hearing, adjust the equalizer to an appropriate level.**

Excessive use of headphones or earphones for a long period of time at high volume can be dangerous if the output of the headphone or earphone connectors do not comply with specifications of EN 50332-2. The headphone output connector of your computer complies with EN 50332-2 Sub clause 7. This specification limits the computer's maximum wide band true RMS output voltage to 150 mV. To help protect against hearing loss, ensure that the headphones or earphones you use also comply with EN 50332-2 (Clause 7 limits) for a wide band characteristic voltage of 75 mV. Using headphones that do not comply with EN 50332-2 can be dangerous due to excessive sound pressure levels.

If your Lenovo computer came with headphones or earphones in the package, as a set, the combination of the headphones or earphones and the computer already complies with the specifications of EN 50332-1. If different headphones or earphones are used, ensure that they comply with EN 50332-1 (Clause 6.5 Limitation Values). Using headphones that do not comply with EN 50332-1 can be dangerous due to excessive sound pressure levels.

## Additional safety information



**Plastic bags can be dangerous. Keep plastic bags away from babies and children to avoid danger of suffocation.**

### Notice for users in the U.S.A.

Many personal computer products and accessories contain cords, cables or wires, such as power cords or cords to connect the accessory to a personal computer. If this product has such a cord, cable or wire, then the following warning applies:

**WARNING:** Handling the cord on this product or cords associated with accessories sold with this product will expose you to lead, a chemical known to the State of California to cause cancer, and birth defects or other reproductive harm. ***Wash hands after handling.***

Save these instructions.



---

## Chapter 1. Product overview

This chapter provides information about the locations of connectors, locations of important product labels, computer features, specifications, operating environment, and ThinkVantage® Technologies and other software.

- “Locating computer controls, connectors, and indicators” on page 1
- “Locating important product information” on page 9
- “Features” on page 11
- “Specifications” on page 12
- “Operating environment” on page 13
- “ThinkVantage Technologies and software” on page 13

---

### Locating computer controls, connectors, and indicators

This section introduces the computer hardware features to give you the basic information you will need to start using the computer.

#### Front view



Figure 1. ThinkPad X230 and X230i front view

<b>1</b> Integrated camera	<b>2</b> ThinkLight® light
<b>3</b> Status indicators	<b>4</b> Power button
<b>5</b> TrackPoint® pointing stick	<b>6</b> PCI Express Mini Card slot for wireless LAN/WiMAX card

<b>7</b> PCI Express Mini Card slot for wireless WAN card or mSATA solid state drive	<b>8</b> Fingerprint reader
<b>9</b> TrackPoint buttons	<b>10</b> Touch pad
<b>11</b> Fn key	<b>12</b> Volume control buttons
<b>13</b> Black button	<b>14</b> Built-in microphones

## **1 Integrated camera**

Some models have an integrated camera. Use the camera to take pictures or hold a video conference. For more information, see “Using the integrated camera” on page 40.

## **2 ThinkLight light**

The ThinkLight light enables you to use your computer when the lighting condition is not ideal. To turn on the ThinkLight light, press the Fn key and the space key together. To turn it off, press the combination again.

### **CAUTION:**

**Avoid using your computer in dark conditions for prolonged periods. It is bad for your eyes.**

## **3 Status indicators**

Your computer has several status indicators. For the detailed information about the location and meaning of each indicator, see “Status indicators” on page 7.

## **4 Power button**

Use the power button to turn on the computer. To turn off the computer, use the **Start** menu shutdown option.

If your computer stops responding and you cannot turn it off, press and hold the power button for four seconds or more. If the computer still is not responding, remove the ac power adapter and the battery to reset the computer.

The power button also can be programmed through the Power Manager program to shut down the computer or put it into sleep or hibernation mode. For more information, see the help information system of the Power Manager program.

## **UltraNav® pointing device**

### **5 TrackPoint pointing stick**

### **9 TrackPoint buttons**

### **10 Touch pad**

The keyboard contains the Lenovo unique UltraNav pointing device. Pointing, selecting, and dragging are all part of a single process that you can perform without moving your fingers from a typing position. For more information, see “Using the UltraNav pointing device” on page 24.

## **6 PCI Express Mini Card slot for wireless LAN/WiMAX**

Your computer might include a wireless local area network (LAN) card or a wireless combo card for LAN and Worldwide Interoperability for Microwave Access (WiMAX) in the PCI Express Mini Card slot for you to establish wireless LAN/WiMAX connections.

## **7 PCI Express Mini Card slot for wireless WAN card or mSATA solid state drive**

Your computer might have a wireless wide area network (WAN) card installed in the PCI Express Mini Card slot for wireless WAN connections.

Some models are equipped with an mSATA solid state drive for data storage.

## 8 Fingerprint reader

Some models have a fingerprint reader. The fingerprint authentication technology enables you to use your fingerprint to start the computer, enter the ThinkPad Setup program, or enter the Windows operating system. For details, see “Using the fingerprint reader” on page 56.

## 11 Fn key

Use the Fn key to take advantage of ThinkPad® function keys, such as turning on the ThinkLight light, locking the computer, managing the wireless connections, and so on. For more information, see “Function key combinations” on page 20.

## 12 Volume control buttons

The volume control buttons enable you to quickly adjust the sound volume, mute the speakers, or mute the microphones of your computer. For more information, see “Volume and mute buttons” on page 23.

## 13 Black button

When the operating system is working normally, press the black button to launch the SimpleTap program on the Windows® 7 operating system.

You also can use this button to interrupt the startup sequence of your computer to start the Rescue and Recovery® workspace. To access the Rescue and Recovery workspace, turn on your computer and press this button when the ThinkPad logo is displayed on the screen. For more information about Rescue and Recovery, see “Using the Rescue and Recovery workspace” on page 63.

## 14 Built-in microphones

The built-in microphones capture sound and voice when used with an application program capable of handling audio.

## Right-side view



Figure 2. ThinkPad X230 and X230i right-side view

1 Security keyhole	2 Hard disk drive or solid state drive
3 Combo audio jack	4 Ethernet connector
5 Always On USB connector	6 Media card reader slot

## **1 Security keyhole**

Purchase a security cable lock that fits this keyhole to lock your computer to a stationary object to protect your computer from theft.

## **2 Hard disk drive or solid state drive**

Depending on the model, your computer might have a large-capacity, customer-upgradable hard disk drive that can meet a variety of storage demands.

Some models are equipped with a solid state drive for data storage, making your computer lighter, smaller, and faster.

**Note:** The hidden service partition is the reason why there is less free space than expected on your hard disk drive or solid state drive. This reduction is more noticeable on the solid state drive because of its smaller capacity.

## **3 Combo audio jack**

To listen to the sound from your computer, connect a headphone or a headset that has a 3.5 mm 4-pole plug to the combo audio jack.

### **Notes:**

- If you are using a headset with a function switch, for example, a headset for an iPhone® mobile digital device, do not press this switch while using the headset. If you press it, the headset microphone will be disabled, and the integrated microphones on the computer will be enabled instead.
- The combo audio jack does not support a conventional microphone. For more information, see “Using audio features” on page 40.

## **4 Ethernet connector**

Connect your computer to a LAN with the Ethernet connector.



**DANGER**

**To avoid the risk of electrical shock, do not connect the telephone cable to the Ethernet connector. You can only connect an Ethernet cable to this connector.**

Two indicators, to the upper right and left of the connector, show the status of the network connection. When your computer connects to a LAN and a session with the network is available, the upper left indicator is steady green. While data is being transmitted, the upper right indicator blinks yellow.

**Note:** If you attach your computer to a ThinkPad Ultrabase, docking station, or replicator, use the Ethernet connector on the Ultrabase, docking station, or replicator to connect to a LAN, not the one on the computer.

## **5 Always On USB connector**

By default, the Always On USB connector enables you to charge some devices, such as iPod®, iPhone, and BlackBerry® smartphones when your computer is in sleep or hibernation mode.

If you want to charge these devices when your computer is turned off, you need to connect the computer to ac power supply and change the Always On USB settings in ThinkPad Setup and the Power Manager program. For more information, see “Config menu” on page 109.

## 6 Media card reader slot

Your computer has a media card reader slot. For more information about the supported cards, see “Using an ExpressCard, a flash media card, or a smart card” on page 41.

## Left-side view



Figure 3. ThinkPad X230 and X230i left-side view

1 ExpressCard slot	2 Wireless radio switch
3 USB 3.0 connector	4 Mini DisplayPort connector
5 Video graphics array (VGA) connector	6 USB 3.0 connector
7 Fan louvers	

### 1 ExpressCard slot

Your computer has an ExpressCard slot for a 54 mm-wide ExpressCard or a smart card. For more information, see “Using an ExpressCard, a flash media card, or a smart card” on page 41.

### 2 Wireless radio switch

Use this switch to quickly turn on or turn off all wireless connections.

### 3 6 USB 3.0 connectors

The Universal Serial Bus (USB) 3.0 connectors are used for connecting devices compatible with a USB interface, such as a USB printer or a digital camera.

**Note:** When you attach a USB cable to the connector, make sure that the USB mark is facing upward. Otherwise the connector might be damaged.

### 4 Mini DisplayPort connector

Use the mini DisplayPort connector to connect your computer to a compatible projector, external monitor, or high-definition television.

### 5 Video graphics array (VGA) connector

Attach a VGA compatible monitor or projector to your computer to display the computer output.

**Note:** If you attach your computer to a ThinkPad Ultrabase, docking station, or port replicator, use the VGA connector on the Ultrabase, docking station, or replicator, not the one on the computer.

For details, see “Attaching an external monitor” on page 36.

## 7 Fan louvers

The internal fan and louvers enable air to circulate in the computer and cool the central processor.

**Note:** To avoid impeding airflow, do not place any obstacle in front of the fan.

## Bottom view

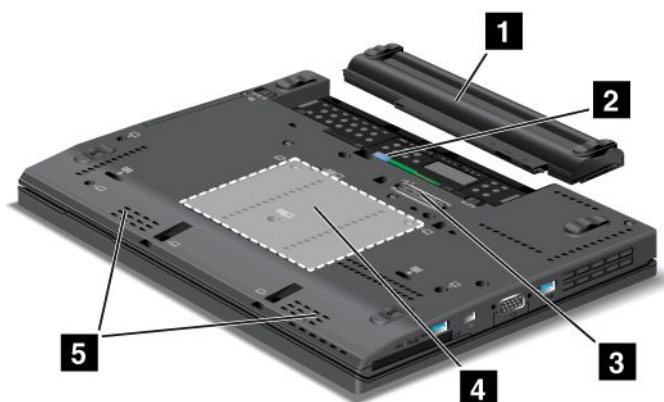

Figure 4. ThinkPad X230 and X230i bottom view

<b>1</b> Battery	<b>2</b> SIM card slot
<b>3</b> Docking station connector	<b>4</b> Memory-upgrade slot
<b>5</b> Built-in speakers	

### 1 Battery

Use your computer with the battery power whenever ac power is unavailable.

You can use the Power Manager program to adjust your power settings as needed. For details, see the help information system of the Power Manager program.

### 2 SIM card slot

If your computer has a wireless WAN feature, it might require a Subscriber Identification Module (SIM) card to establish wireless WAN connections. Depending on the country of delivery, the SIM card might already be installed in the SIM card slot.

### 3 Docking station connector

Connect your computer to a supported ThinkPad Ultrabase, port replicator, or docking station through this connector to extend the computer capabilities when you are in your office or at home. For more information about the supported docking stations, see Chapter 7 “Enhancing your computer” on page 87.



#### 4 Memory-upgrade slot

You can increase the amount of memory in your computer by installing a memory module in the memory-upgrade slot. Memory modules are available as options from Lenovo. For more information, see “Replacing a memory module” on page 73.

#### 5 Built-in speakers

The stereo speakers are built into your computer.

## Rear view



Figure 5. ThinkPad X230 and X230i rear view

<b>1</b> Power jack	<b>2</b> Fan louvers
---------------------	----------------------

#### 1 Power jack

Connect the ac power adapter to the power jack to provide ac power to the computer and charge the battery.

#### 2 Fan louvers

The internal fan and louvers enable air to circulate in the computer and cool the central processor.

**Note:** To avoid impeding airflow, do not place any obstacle in front of the fan.

## Status indicators

Your computer has system-status indicators and power-status indicators. The status indicators show the current status of your computer.

## System-status indicators



### 1 Wireless LAN/WAN/WiMAX/Bluetooth status indicator

- **Green:** The wireless LAN, WAN, Bluetooth or WiMAX feature is on.
- **Off:** Wireless network devices are disabled or the wireless radio is turned off.

### 2 Device access status indicator

The hard disk drive, solid state drive, or mSATA solid state drive is reading or writing data.

**Note:** When this indicator is blinking, do not put the computer into sleep mode, remove the drive, or turn off the computer.

### 3 Power on status indicator

The power button stays lit whenever the computer is on, blinks when the computer is in sleep mode, and is off when the computer is turned off.

## Power status indicators

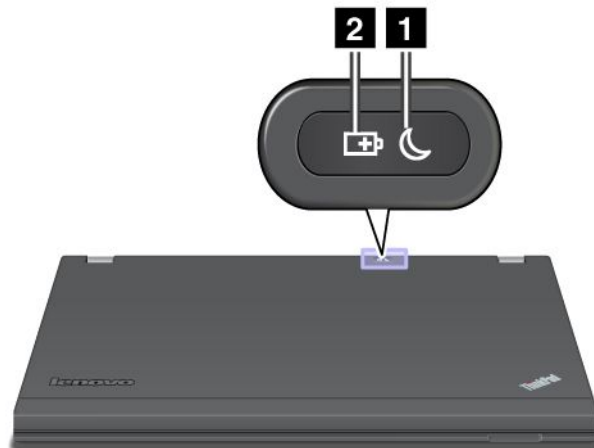

## 1 Sleep status indicator

- **Green:** The computer is in sleep mode.
- **Blinking green:** The computer is entering sleep or hibernation mode, or is resuming normal operation.

## 2 Battery status indicator

- **Green:** The battery charge level is 20% or higher
- **Orange:** The battery charge level is between 5% and 20%.
- **Fast blinking orange:** The battery charge level is 5% or less.
- **Slow blinking orange:** The battery is being charged. When the charge level reaches 20%, the blinking color changes to green.
- **Slow blinking green:** The battery charge level is between 20% and 80%, and charging is continuing. When the battery charge level reaches 80%, the battery status indicator stops blinking, but the charging might continue until the battery is 100% charged.

**Note:** If the computer is operating on battery power, the battery status indicator does not work while the computer is turned off or is in sleep mode or hibernation mode.

- **Quick blinking orange:** An error occurred in the battery.
- **The battery status indicator blinks three times:** The ac power adapter is attached to the computer.
- **The battery status indicator is off:** The battery is fully charged or the battery is detached.

---

## Locating important product information

This section provides information to help you locate your machine type and model label, FCC ID and IC Certification label, and Microsoft® Certificate of Authenticity (COA) label.

### Machine type and model label

The machine type and model label identifies your computer. If you contact Lenovo for help, the machine type and model number will help support technicians to identify your computer and provide the highest level of service.

You can find the machine type and model of your computer in the label as shown below:

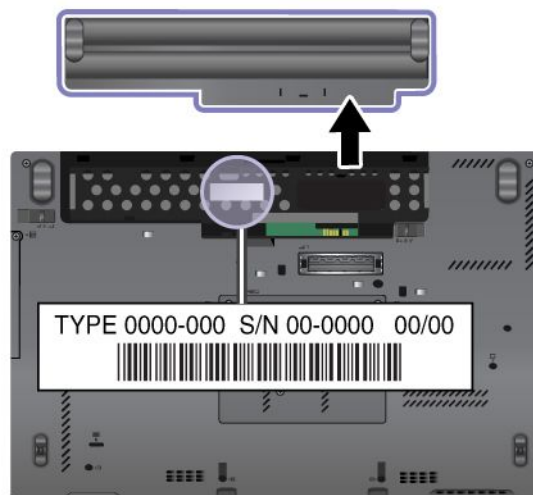

## FCC ID and IC Certification number label

There is no FCC ID or IC Certification number for the PCI Express Mini Card shown on the enclosure of your computer. The FCC ID and IC Certification number label is affixed on the card installed in the PCI Express Mini Card slot of your computer.

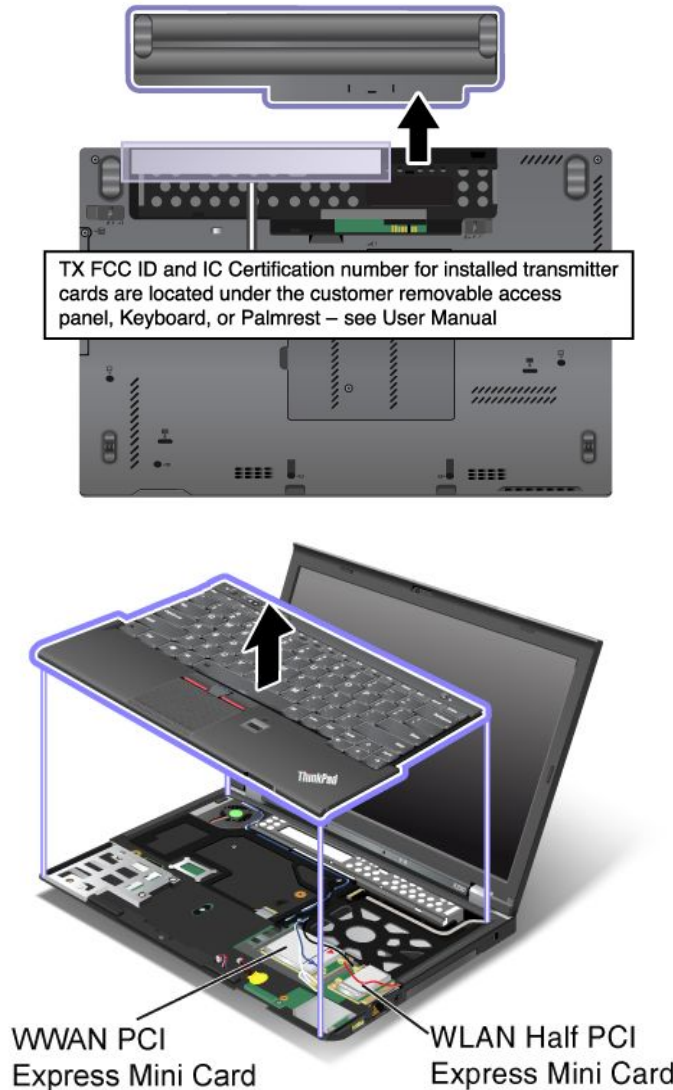

## Certificate of Authenticity label

The Microsoft Certificate of Authenticity label for the preinstalled operating system is attached. Printed on this label are the product ID and the product key information for your computer. Record this information and keep it in a safe place. You might need these numbers to start your computer or reinstall the operating system.

The Windows Certificate of Authenticity of your computer is shown as below:

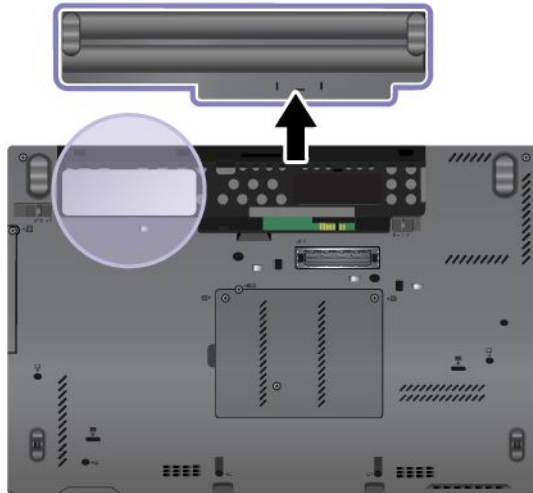

---

## Features

### Processor

- To view the processor information of your computer, click **Start**, right-click **Computer**. Then click **Properties**.

### Memory

- Double data rate 3 (DDR3) synchronous dynamic random access memory (SDRAM)

### Storage device

Depending on the model:

- 2.5-inch (7 mm height) hard disk drive
- 2.5-inch (7 mm height) solid state drive

### System performance

- mSATA solid state drive

### Display

- The color display uses the TFT technology
- Display size: 12.5 inches (317.5 mm)
- Display resolution: 1366-by-768
- ThinkLight light
- Integrated camera
- Built-in microphones

### Keyboard

- 6-row backlit keyboard or 6-row standard keyboard (depending on the model)
- UltraNav pointing device
- Fn key function
- Volume control buttons

- Speaker mute button
- Microphone mute button

### **Interface**

- External monitor connectors (VGA and Mini DisplayPort)
- Combo audio jack
- Two USB 3.0 connectors and one Always On USB 2.0 connector
- RJ45 Ethernet connector
- ExpressCard slot
- 4-in-1 digital media card reader
- Docking station connector

### **Wireless features**

- Integrated wireless LAN
- Integrated Bluetooth (on some models)
- Integrated wireless WAN (on some models)
- Integrated WiMAX (on some models)

### **Security features**

- Fingerprint reader (on some models)

---

## **Specifications**

### **Size**

- Width: 305.0 mm (12 inches)
- Depth: 206.5 mm (8.13 inches)
- Height: 19 to 26.6 mm (0.75 inches to 1.05 inches)

### **Heat output**

- 65 W (222 Btu/hr) maximum or 90 W (307 Btu/hr) maximum, depending on the model

### **Power source (ac power adapter)**

- Sine-wave input at 50 to 60 Hz
- Input rating of the ac power adapter: 100 to 240 V ac, 50 to 60 Hz

### **Battery pack**

- Lithium-ion (Li-Ion) battery pack

### **Battery life**

- For percentage of remaining battery power, check the Power Manager battery gauge on the taskbar.
- The Power Manager program also displays a green, yellow and red indication. A battery under warranty with a red indication is eligible for a warranty replacement.

---

## Operating environment

This section provides information about your computer operating environment.

### Environment

- Maximum altitude without pressurization: 3048 m (10,000 ft)
- Temperature

- At altitudes up to 2438 m (8000 ft)
  - Operating: 5.0°C to 35.0°C (41°F to 95°F)
  - Storage: 5.0°C to 43.0°C (41°F to 109°F)
- At altitudes above 2438 m (8000 ft)

Maximum temperature when operating under the unpressurized condition: 31.3°C (88°F)

**Note:** When you charge the battery pack, its temperature must be at least 10°C (50°F).

- Relative humidity:
  - Operating: 8% to 80%
  - Storage: 5% to 95%

If possible, place your computer in a well-ventilated and dry area without direct exposure to sunshine.

Keep electrical appliances such as an electric fan, radio, high-powered speakers, air conditioner, and microwave oven away from your computer because the strong magnetic fields generated by these appliances can damage the monitor and data on the hard disk drive or solid state drive.

Do not place any beverages on top of or beside the computer or other attached devices. If liquid is spilled on or in the computer or an attached device, a short circuit or other damage might occur.

Do not eat or smoke over your keyboard. Particles that fall into your keyboard can cause damage.

---

## ThinkVantage Technologies and software

ThinkVantage Technologies and some other software programs are preinstalled on your computer to help you work more easily and securely.

To learn more about ThinkVantage Technologies and other computing solutions offered by Lenovo, go to <http://www.lenovo.com/support>.

## Accessing ThinkVantage applications on the Windows 7 operating system

On the Windows 7 operating system, you can access ThinkVantage applications from either the Lenovo ThinkVantage Tools program or from Control Panel.

### Accessing applications from the Lenovo ThinkVantage Tools program

To access applications from the Lenovo ThinkVantage Tools program, click **Start → All Programs → Lenovo ThinkVantage Tools**. Then double-click an application icon to access the application.

**Note:** If an application icon in the Lenovo ThinkVantage Tools application navigation window is dimmed, it indicates that you need to install the application manually. To install the application manually, double-click

the application icon. Then, follow the instructions on the screen. When the installation process completes, the application icon will be activated.

Table 1. Applications in the Lenovo ThinkVantage Tools program

Application	Icon name
Access Connections™	Internet Connection
Active Protection System™	Airbag Protection
Client Security Solution	Enhanced Security
Communications Utility	Web Conferencing
Fingerprint Software	Fingerprint Reader
GPS Enabler	GPS
Lenovo Solution Center	System Health and Diagnostics
Mobile Broadband Connect	3G Mobile Broadband
Password Manager	Password Vault
Power Manager	Power Controls
Recovery Media	Factory Recovery Disks
Rescue and Recovery®	Enhanced Backup and Restore
Screen Reader Optimizer	Reading Optimization
SimpleTap	SimpleTap
System Update	Update and Drivers

**Note:** Depending on your computer model, some of the applications might not be available.

### Accessing applications from Control Panel

To access applications from Control Panel, click **Start → Control Panel**. Then depending on the application you want to access, click the corresponding section and then click the corresponding green text.

**Note:** If you do not find the application you need in Control Panel, open the Lenovo ThinkVantage Tools application navigation window and double-click the dimmed icon to install the application you need. Then, follow the instructions on the screen. When the installation process completes, the application icon will be activated, and you can find the application in Control Panel.

The applications and the corresponding sections and green texts in Control Panel are listed in the following table.

Table 2. Applications in Control Panel

Application	Control Panel section	Green text in Control Panel
Access Connections	Network and Internet	Lenovo - Internet Connection
Active Protection System	System and Security Hardware and Sound	Lenovo - Airbag Protection
Client Security Solution	System and Security	Lenovo - Enhanced Security
Communications Utility	Hardware and Sound	Lenovo - Web Conferencing



Table 2. Applications in Control Panel (continued)

Application	Control Panel section	Green text in Control Panel
Fingerprint Software	System and Security Hardware and Sound	Lenovo - Fingerprint Reader or Lenovo - Notebook Fingerprint Reader
GPS Enabler	Network and Internet System and Security	Lenovo - GPS
Lenovo AutoLock	System and Security	Lenovo - Camera-enhanced security
Lenovo Solution Center	System and Security	Lenovo - System Health and Diagnostics
Message Center Plus	Programs	Messages from Lenovo
Password Manager	System and Security User Accounts and Family Safety	Lenovo - Password Vault
Power Manager	Hardware and Sound System and Security	Lenovo - Power Controls
Recovery Media	System and Security	Lenovo - Factory Recovery Disks
Screen Reader Optimizer	Appearance and Personalization	Lenovo - Reading Optimization
SimpleTap	Programs	Lenovo - SimpleTap
System Update	System and Security	Lenovo - Update and Drivers
Rescue and Recovery	System and Security	Lenovo - Enhanced Backup and Restore

**Note:** Depending on your computer model, some of the applications might not be available.

## ThinkVantage applications

This topic provides a brief introduction to some ThinkVantage applications.

**Note:** Depending on your computer model, some of the applications might not be available.

### Access Connections

The Access Connections program is a connectivity assistant program for creating and managing location profiles. Each location profile stores all the network and Internet configuration settings needed for connecting to a network infrastructure from a specific location such as a home or an office.

By switching between location profiles as you move your computer from place to place, you can quickly and easily connect to a network with no need to reconfigure your settings manually and restart the computer each time.

### Active Protection System

The Active Protection System program protects your hard disk drive when the shock sensor inside your computer detects a condition that could damage the drive, such as system tilt, excessive vibration, or shock. The hard disk drive is less vulnerable to damage when it is not operating. This is because when the hard disk drive is not operating, the system stops it from spinning, and might also move the read and write heads of the drive to areas that do not contain data. As soon as the shock sensor senses that the environment is stable again (minimal change in system tilt, vibration, or shock), it turns the hard disk drive on.

## **Client Security Solution**

The Client Security Solution program protects your computer by securing client data and deflecting security breach attempts. It also can help manage your passwords, recover a forgotten password, monitor security settings on your computer, and suggest how to enhance your computer security.

## **Communications Utility**

Use the ThinkVantage Communications Utility program to configure settings for the integrated camera and audio devices.

## **Fingerprint Software**

If your system comes with a fingerprint reader, the Fingerprint Software program enables you to enroll your fingerprint and associate it with your Windows password. As a result, the fingerprint authentication can replace your password and enable simple and secure user access.

## **GPS Enabler**

If the PCI Express Mini Card installed in your computer supports GPS, your computer can receive signals from GPS satellites and determine its location. If your computer is connected to the Internet, you can find your location on a real-time map provided by Google Maps or Microsoft Bing™ Maps.

## **Lenovo AutoLock**

To help guard against unauthorized use, the Lenovo AutoLock program automatically locks the computer screen when the integrated camera does not detect human presence through facial feature recognition. The integrated camera starts detecting facial feature when there is no activity from the keyboard or mouse for a certain period of time.

## **Lenovo Solutions Center**

The Lenovo Solution Center program enables you to troubleshoot and resolve computer problems. It combines diagnostic tests, system information collection, security status, and support information, along with hints and tips for maximum system performance.

## **Lenovo ThinkVantage Tools**

The Lenovo ThinkVantage Tools program helps you work more easily and securely by providing easy access to various technologies, such as:

- Lenovo Solution Center
- Power Manager
- Rescue and Recovery
- System Update

## **Message Center Plus**

The Message Center Plus program automatically displays messages to inform you about important notices from Lenovo, such as alerts on system updates and alerts on conditions that require your attention.

## **Mobile Broadband Connect**

The Mobile Broadband Connect program enables your computer to connect to the mobile broadband (3G) network through a supported wireless WAN card.

To open the Mobile Broadband Connect program, open Control Panel and click **Network and Internet** → **Lenovo - Internet Connection** → **Setup Mobile Broadband**.

## **Password Manager**

The Password Manager program automatically captures and fills in authentication information for Windows applications and Web sites.

## **Power Manager**

The Power Manager program provides convenient, flexible, and complete power management for your computer. It enables you to adjust your computer power settings to achieve the best balance between performance and power saving.

## **Recovery Media**

The Recovery Media program enables you to restore the contents of the hard disk drive to the factory default settings.

## **Rescue and Recovery**

The Rescue and Recovery program is a one-button recovery and restore solution that includes a set of self-recovery tools to help you diagnose computer problems, get help, and recover from system crashes, even if you cannot start the Windows operating system.

## **Screen Reader Optimizer**

The Screen Reader Optimizer program enables you to achieve the best reading experience by setting your preferred screen brightness level and rotating the screen for the most comfortable reading position.

## **SimpleTap**

The SimpleTap program provides you with a quick way to customize some basic computer settings such as muting the speakers, adjusting the volume, locking the computer operating system, launching a program, opening a Web page, opening a file, and so on. You also can use the SimpleTap program to access the Lenovo App Shop, from which you can download various applications and computer software.

To start the SimpleTap program in a quick way, do any of the following:

- Click the red SimpleTap launch point on the desktop. The red launch point is available on the desktop after you have launched the SimpleTap program for the first time.
- Press the black button on the keyboard (next to the volume control buttons).

**Note:** The SimpleTap program is only available on certain models preinstalled with the Windows 7 operating system. If your Windows 7 model is not preinstalled with the SimpleTap program, you can download it from <http://www.lenovo.com/support>.

## **System Update**

The System Update program helps you keep the software on your computer up-to-date by downloading and installing software packages (ThinkVantage applications, device drivers, UEFI BIOS updates, and other third party applications).



---

## Chapter 2. Using your computer

This chapter provides information on using some of the computer components.

- “Registering your computer” on page 19
- “Frequently asked questions” on page 19
- “Special keys and buttons” on page 20
- “Using the UltraNav pointing device” on page 24
- “Power management” on page 28
- “Connecting to the network” on page 32
- “Presentations and multimedia” on page 36
- “Using audio features” on page 40
- “Using the integrated camera” on page 40
- “Using an ExpressCard, a flash media card, or a smart card” on page 41

---

### Registering your computer

When you register your computer, information is entered into a database, which enables Lenovo to contact you in case of a recall or other severe problem. After you register your computer with Lenovo, you will receive quicker service when you call Lenovo for help. In addition, some locations offer extended privileges and services to registered users.

To register your computer with Lenovo, do one of the following:

- Lenovo has preloaded a registration application that will launch automatically after you have used your computer for a time. Follow the instructions on the screen to register your computer with Lenovo.
- Go to <http://www.lenovo.com/register> and follow the instructions on the screen to register your computer with Lenovo.

---

### Frequently asked questions

Here are a few tips that will help you optimize the use of ThinkPad notebook.

To ensure that you receive the best performance from your computer, browse the following Web page to find information such as aids for troubleshooting and answers to frequently asked questions:

<http://www.lenovo.com/support/faq>.

#### Can I get my user guide in another language?

- To download the user guide in another language, go to: <http://www.lenovo.com/support>. Then follow the instructions on the screen.

#### On the go and need to use battery power more effectively?

- To conserve power, or to suspend operation without exiting applications or saving files, see “Power-saving modes” on page 29.
- To achieve the best balance between performance and power saving, create and apply power plans by use of the Power Manager program.
- If your computer will be turned off for an extended period of time, you can prevent battery power from draining by removing the battery. For more information, see “Power management” on page 28.

### **Concerned about security or need to securely dispose of data stored on your hard disk or solid state drive?**

- Study the Chapter 4 “Security” on page 49 to find out how you can protect your computer from theft and unauthorized use.
- Use the Client Security Solution program or Password Manager program to protect the data stored on your computer.
- Before you dispose of the data on the hard disk drive or the solid state drive, be sure to read the topic “Notice on deleting data from your hard disk drive or solid state drive” on page 59.

### **Getting connected in different locations is a challenge?**

- To troubleshoot a wireless networking issue, go to <http://www.lenovo.com/support/faq>.
- Take advantage of the networking features by use of the Access Connections program.
- To learn more about using the wireless features of your computer, refer to “Wireless connections” on page 32.
- To travel more confidently, be sure to check the tips in “Traveling with your computer” on page 47.
- Press Fn+F5, or use the wireless radio switch to enable or disable the wireless features.

### **Need to give presentations or attach an external monitor often?**

- Make sure that you follow the procedure in the topic “Attaching an external monitor” on page 36.
- With the Extend desktop function, you can display output on both the computer display and the external monitor. See “Using the Extend desktop function” on page 39.

### **Need to attach or replace a device?**

- See Chapter 6 “Replacing devices” on page 67 for more information about replacing the devices of your computer.
- See Chapter 7 “Enhancing your computer” on page 87 for more information about enhancing the features of your computer.

### **You have been using your computer for some time already, and it is getting slower?**

- Follow the “General tips for preventing problems” on page 125.
- Diagnose problems yourself by using the preinstalled diagnostic software. See “Diagnosing problems” on page 131.
- Also recovery tool is provided on your computer hard disk or solid state drive. For more information, see Chapter 5 “Recovery overview” on page 61.

### **Print the following sections and keep them with your computer in case you are unable to access this online help when necessary.**

- “Installing a new operating system” on page 105
- “Computer stops responding” on page 131
- “Power problems” on page 143

---

## **Special keys and buttons**

Your computer has several special keys and buttons to help you work more easily and effectively.

### **Function key combinations**

To use the function key combinations, press and hold the Fn key **1**, then press one of the function keys **2**.



## Power conservation

### Fn+F4

Put your computer into sleep mode. To return to normal operation, press the Fn key only.

If you want to use the combination to put the computer into hibernation mode or do-nothing mode, change the settings in the Power Manager program.

## Switching a display output location

### • Fn+F7

Switch the display output location between the computer display and an external monitor by selecting one of the following options:

- Computer display only
- Computer display and external monitor (same image)
- Computer display and external monitor (extended desktop function)
- External monitor only

**Note:** The Windows+P key combination has the same functionality as Fn+F7.

## Enabling or disabling the wireless features

### • Fn+F5

Enable or disable the built-in wireless networking features.

**Notes:** To use this function, the following device drivers must be installed on your computer beforehand:

- Power Manager driver
- OnScreen Display Utility
- Wireless device drivers

You can download these drivers from <http://www.lenovo.com/ThinkPadDrivers>.

## Changing the camera and audio settings

- **Fn+F6**

Press Fn+F6 to open the Communications settings window. From this window, you can take a picture, change the camera and audio settings, and launch the Communications Utility program.

## Adjusting the brightness level of the computer display

- **Fn+F8:** The computer display becomes dimmer.
- **Fn+F9:** The computer display becomes brighter.

This function changes the brightness level temporarily. To change the default brightness level, change the settings through the Power Manager program.

## Multimedia controls

- **Fn+F10:** Previous track/scene
- **Fn+F11:** Play or pause
- **Fn+F12:** Next track/scene

## Other functions

- **Fn+Spacebar:** Control the keyboard backlight and the ThinkLight light:
  - Press once: Turn on the keyboard backlight to low brightness level.
  - Press again: Adjust the keyboard backlight to high brightness level.
  - Press the third time: Turn off the keyboard backlight and turn on the ThinkLight light.
  - Press the fourth time: Turn off the ThinkLight light.

**Note:** If your computer does not have a backlit keyboard, the Fn+Spacebar combination controls only the ThinkLight light.

To change the functionality of this combination, see “Config menu” on page 109.

- **Fn+F3:** Lock your computer.
- **Fn+B:** Have the same function as the Break key on a conventional keyboard.
- **Fn+P:** Have the same function as the Pause key on a conventional keyboard.
- **Fn+S:** Have the same function as the SysRq key on a conventional keyboard.
- **Fn+K:** Have the same function as the ScrLK key on a conventional keyboard.



## Volume and mute buttons

Adjust the sound volume level of the built-in speakers by using the following three buttons:



- 1 Speaker mute button**
- 2 Volume control button**
- 3 Microphone mute button**

If you mute the sound and then turn off your computer, the sound will remain muted when you turn on your computer again. To turn on the sound, press the speaker mute button again or press the volume control button.

### Setting the volume

To adjust the output volume or the recording volume on the Windows 7 operating system, do the following:

1. Click **Start → Control Panel → Hardware and Sound → Sound**. The Sound window opens.
2. Click the **Playback** tab or **Recording** tab, and then click a device that you want to customize.
3. Click the **Properties** button.
4. Click the **Levels** tab, and then change the volume by moving the slider.

You also can get access to the desktop volume control by using the volume icon on the taskbar at the lower right of the screen. For details about controlling volume, refer to your Windows help information system.

### Setting the microphone mute button

By default, when you press the microphone mute button, all of the recording devices are set on mute or unmute.

If you want to control only one of the recording devices using the microphone mute button, do the following:

1. Press **Fn+F6**. The Communications Settings window opens.
2. Click the **Manage Settings** button. The Communications Utility window opens.
3. On the **VoIP Call Settings** tab, click **Microphone mute button settings**. The Setting for Microphone Mute window opens.

4. Select **Only the recording device selected below:**. Then select the recording device from the drop-down list box.
5. Click **OK**.

## Windows key



Press this key to open the **Start** menu of the Windows operating system.

You also can use the Windows key together with another key to achieve other functions. For details, refer to the help information system of the Windows operating system.

---

## Using the UltraNav pointing device

Your computer comes with the UltraNav pointing device. The UltraNav pointing device consists of the TrackPoint pointing device and the touch pad, each of which is itself a pointing device with both basic and extended functions. You can configure both devices by choosing the settings you prefer.

- **Set both the TrackPoint pointing device and the touch pad as pointing devices.**

This setting enables the use of all the basic and extended functions of the TrackPoint pointing device and the touch pad.
- **Set the TrackPoint pointing device as the main pointing device and the touch pad for extended functions only.**

This setting enables the use of all basic and extended functions with the TrackPoint pointing device while limiting the use of the touch pad to scrolling, tap zones, or slow-motion pointer functions.
- **Set the touch pad as the main pointing device and the TrackPoint pointing device for the extended functions only.**

This setting enables the use of all basic and extended functions with the touch pad while limiting the use of the TrackPoint pointing device to scrolling or Magnifying Glass functions.
- **Set the TrackPoint pointing device as the main pointing device, and disable the touch pad.**
- **Set the touch pad as the main pointing device, and disable the TrackPoint pointing device.**

## Changing the UltraNav pointing device settings

To change your UltraNav pointing device settings, click **Start** → **Control Panel** → **Hardware and Sound** → **Mouse** → **UltraNav**. Then change the settings as you desired.

## Using the TrackPoint pointing device

The TrackPoint pointing device consists of a pointing stick **1** on the keyboard and three click buttons at the bottom of the keyboard. To move the pointer **5** on the screen, apply pressure to the nonslip cap on the pointing stick in any direction parallel to the keyboard; the pointing stick itself does not move. The speed at which the pointer moves depends on the pressure you apply to the pointing stick. The functions of the left **4** and right **2** click buttons correspond to those of the left and right mouse buttons on a conventional mouse. The TrackPoint center button **3**, called the scroll bar, enables you to scroll Web pages or documents in any direction with no need to use the graphic scroll bars on the side of the window.

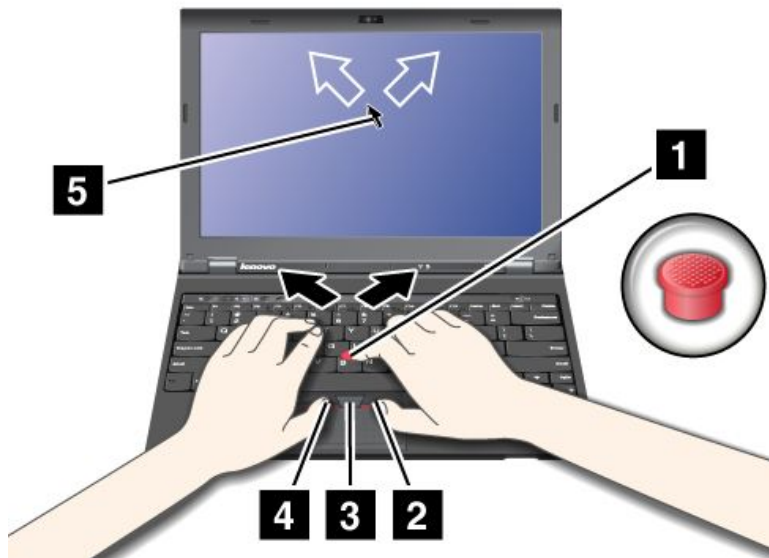

If you are not familiar with the TrackPoint, these instructions will help you get started:

1. Place your hands in the typing position, and press gently with either index finger on the pointing stick in the direction in which you want the pointer to move.

To move the pointer, press the pointing stick away from you to move it up, toward you to move it down, to one side or the other to move it sideways.

**Note:** The pointer might drift. This is not a defect. Stop using the TrackPoint pointing device for a few seconds, then the pointer will stop moving.

2. To select and drag as required by your software, press the left or right click button with either thumb and move the TrackPoint pointing stick.

By enabling Press-to-Select, you can make the TrackPoint pointing stick function the same as the left or right click button.

## Customizing the settings of the TrackPoint pointing device

You can customize the TrackPoint pointing device and its buttons as follows:

- Switch the functions of the left and right buttons.
- Change the sensitivity of the TrackPoint.
- Enable the Press-to-Select function.
- Enable the Magnifying Glass function.





### Customizing the touch pad

To customize the touch pad, do as follows:

1. Click **Start → Control Panel → Hardware and Sound → Mouse → UltraNav**.
2. Under TouchPad, proceed to changing the settings.

### Behavior of the UltraNav and an external mouse

If you attach an external mouse to a USB connector, you can use the external mouse simultaneously with the TrackPoint pointing device and the touch pad.

### Disabling the TrackPoint or the touch pad

If you want to disable the TrackPoint or the touch pad, do the following:

1. Click **Start → Control Panel → Hardware and Sound → Mouse → UltraNav**.
2. To disable the TrackPoint pointing device, clear the check box for **Enable TrackPoint**.  
To disable the touch pad, clear the check box for **Enable TouchPad**.
3. Click **OK**.

### Adding the UltraNav icon to the system tray

For easy access to the UltraNav properties, you can enable the display of the **UltraNav** icon in the Windows notification area.

To enable the display of the **UltraNav** icon in the Windows notification area, do the following:

1. Click **Start → Control Panel → Hardware and Sound → Mouse → UltraNav**.
2. Select the check box for **Show UltraNav icon on the system tray**.
3. Click **OK**. You can now change the properties of the UltraNav pointing device by clicking the **UltraNav** icon in the Windows notification area.

**Note:** If you cannot see the **UltraNav** icon, click the triangular icon on the taskbar to show hidden icons.

---

## Power management

When you need to use your computer away from electrical outlets, you depend on battery power to keep your computer running. Different computer components consume power at different rates. The more you use the power-intensive components, the faster you consume battery power.

### Checking battery status

The Power Manager battery gauge on the taskbar displays the percentage of battery power remaining.

The rate at which you use battery power will determine how long you can use the battery of your computer between charges. Because each computer user has different habits and needs, it is difficult to predict how long a battery charge will last. There are two main factors:

- How much energy is stored in the battery when you begin to work.
- The way you use your computer. For example:
  - How often you access the hard disk drive.
  - How bright you make the computer display.
  - How often you use the wireless features.

### Using the ac power adapter

The power to run your computer can come either from the lithium-ion (Li-ion) battery pack, or from ac power through the ac power adapter. While you use ac power, the battery charges automatically.

The ac power adapter that comes with your computer has two basic components:

- The transformer pack that converts ac power adapter for use with the computer.
- The power cord that plugs into the ac outlet and into the transformer pack.

**Attention:** Using an improper power cord might cause severe damage to your computer.

### Connecting the ac power adapter

To use the ac power adapter, do the following. Be sure to take these steps in the order in which they are given here.

1. Connect the ac power adapter to the power jack of the computer.
2. Connect the power cord to the transformer pack.
3. Plug the power cord into an electrical outlet.

### Tips on using the ac power adapter

- When the ac power adapter is not in use, disconnect it from the electrical outlet.
- Do not bind the power cord tightly around the ac power adapter transformer pack when it is connected to the transformer.
- Before you use the ac power adapter to charge the battery, make sure that the battery temperature is at least 10°C (50°F).
- You can charge the battery when the ac power adapter is connected to the computer and the battery is installed. You need to charge it in any of the following conditions:
  - When you purchase a new battery
  - If the battery status indicator starts blinking
  - If the battery has not been used for a long time

## Charging the battery

When you check battery status and find that the percentage of power remaining is low or when the power alarm alerts you that the remaining power is low, you need to charge your battery or replace it with a charged battery.

If an ac outlet is convenient, plug the ac power adapter into it, and then insert the jack into the computer. The battery will be fully charged in about 3 to 6 hours. The charging time is affected by the battery size and the physical environment. You can check the battery charging status at any time by looking at the battery meter icon at the Windows notification area.

**Note:** To increase the life of the battery, the computer does not start recharging the battery if the remaining power is greater than 95%.

## Maximizing battery life

To maximize the life of the battery, do the following:

- Use the battery until the charge is completely depleted, that is, use the battery until the battery status indicator starts blinking orange.
- Recharge the battery completely before using it. The battery is fully charged if the battery indicator shows green when the ac power adapter is plugged in.
- Always use power-saving modes, such as screen blank, sleep, and hibernation.

## Managing your battery power

With the Power Manager program, you can adjust your power settings to give you the best balance between performance and power saving.

For instructions on accessing the Power Manager program, see “Accessing ThinkVantage applications on the Windows 7 operating system” on page 13.

For more information, refer to the help information system of the program.

## Power-saving modes

There are several modes that you can use at any time to conserve power. This section introduces each mode and gives tips on the effective use of the battery power.

### Understanding the power-saving modes

- **Screen blank**

The computer display requires considerable battery power. To turn off power to the display, right-click the battery gauge icon from the Windows notification area and select **Power off display**.

- **Sleep**

In sleep mode, your work is saved to memory, and then the solid state drive or the hard disk drive and the computer display are turned off. When your computer wakes up, your work is restored within seconds.

To put your computer into sleep mode, press Fn+F4. To return from sleep mode, press the Fn key.

Depending on the computer model, your computer might support the 30 Day Standby function. When this function is enabled, the computer consumes even less power in sleep mode and takes only seconds to resume normal operation when you press the power button. For more information about the 30 Day Standby function, refer to the help information system of the Power Manager program.

You also can use the combination to put the computer into hibernation mode or do-nothing mode by changing the settings in the Power Manager program.

- **Hibernation**

By using this mode, you can turn off your computer completely without saving files or exiting from any applications that are running. When the computer enters hibernation, all open applications, folders, and files are saved to the hard disk, and then the computer turns off.

Use the Power Manager program to configure how you want the computer enter hibernation mode. For more information, see the help information system of the Power Manager program.

- **Wireless off**

When you are not using the wireless features, such as Bluetooth or wireless LAN, turn them off. This will help conserve power. To turn off the wireless features, press Fn+F5 or use the wireless radio switch.

### **Enabling the wakeup function**

If you put your computer into hibernation mode, and the wakeup function is disabled (this is the default setting), the computer does not consume any power. If the wakeup function is enabled, it consumes a small amount of power. To enable the wakeup function, do the following:

1. Click **Start → Control Panel → System and Security → Administrative Tools**.
2. Double-click **Task Scheduler**. If you are prompted for an administrator password or confirmation, type the password or provide confirmation.
3. From the left pane, select the task folder for which you want to enable the wakeup function. The scheduled tasks are displayed.
4. Click a scheduled task, and then click the **Conditions** tab.
5. Under **Power**, select the check box for **Wake the computer to run this task**.

### **Enabling the battery alarm**

Program your computer so that when the battery power falls below a certain level, three events occur:

- The alarm goes off.
- A warning message is displayed.
- The LCD is turned off.

To enable the battery alarm, do the following:

1. Start the Power Manager program.
2. Click the **Global Power Settings** tab.
3. For **Low battery alarm** or **Critically low battery alarm**, set the percentage of the power level and set the action.

**Note:** If your computer enters sleep or hibernation mode when the battery is low, but the alarm message has not yet been displayed, the message will be displayed when the computer resumes. To resume normal operation, click **OK**.

## **Handling the battery**

This system supports only batteries specially designed for this specific system and manufactured by Lenovo or an authorized builder. The system does not support unauthorized batteries or batteries designed for other systems. If an unauthorized battery or a battery designed for another system is installed, the system will not charge.

**Attention:** Lenovo has no responsibility for the performance or safety of unauthorized batteries, and provides no warranties for failures or damage arising out of their use.



 **DANGER**

**Do not attempt to disassemble or modify the battery pack.**

**Attempting to do so can cause an explosion, or liquid leakage from the battery pack.**

**A battery pack other than the one specified by Lenovo, or a disassembled or modified battery pack is not covered by the warranty.**

 **DANGER**

**If the rechargeable battery pack is incorrectly replaced, there is danger of an explosion. The battery pack contains a small amount of harmful substances. To avoid possible injury:**

- **Replace only with a battery of the type recommended by Lenovo.**
- **Keep the battery pack away from fire.**
- **Do not expose it to excessive heat.**
- **Do not expose it to water or rain.**
- **Do not short-circuit it.**
- **Store it in a cool dry place.**
- **Keep it away from children.**

The battery pack is a consumable supply. If your battery begins to discharge too quickly, replace the battery pack with a new one of the type recommended by Lenovo. For more information on replacing the battery pack, contact your Customer Support Center.

 **DANGER**

**Do not drop, crush, puncture, or subject to strong forces. Battery abuse or mishandling can cause the battery to overheat, which can cause gasses or flame to “vent” from the battery pack or coin cell. If your battery is damaged, or if you notice any discharge from your battery or the buildup of foreign materials on the battery leads, stop using the battery and obtain a replacement from the battery manufacturer.**

 **DANGER**

**Only recharge the battery pack strictly according to instructions included in the product documentation.**

 **DANGER**

**Do not put the battery pack in trash that is disposed of in landfills. When disposing of the battery, comply with local ordinances or regulations and your company's safety standards.**



**There is a danger of an explosion if the backup battery is incorrectly placed. The lithium battery contains lithium and can explode if it is not properly handled, or disposed of. Replace only with a battery of the same type. To avoid possible injury or death, Do not: (1) throw or immerse into water, (2) allow it to heat to more than 100°C (212°F), or (3) attempt to repair or disassemble it. Dispose of it as required by local ordinances or regulations and your company's safety standards.**

---

## Connecting to the network

Your computer has one or more network cards for connecting to the Internet and to your company's wired LAN or wireless LAN network.

**Note:** Some models come with a built-in wireless WAN card enabling you to establish wireless connections over remote public or private networks.

### Ethernet connections

You can connect to your local network or a broadband connection by use of the Ethernet feature built into your computer.

To connect to a network through Ethernet, use the Access Connections program. For more information, see the help information system of the program.



**Your computer has an Ethernet connector. To avoid the risk of electrical shock, do not connect the telephone cable to the Ethernet connector.**

### Wireless connections

Wireless connection is the transfer of data without the use of cables by means of radio waves only.

Depending on the frequency used for data transmission, the area covered, or the type of the device used for data transfer, the following categories of wireless networks might be available to you.

#### Wireless LAN

A wireless LAN covers a relatively small geographic area, such as an office building or a house. Devices based on the 802.11 standards can connect to this network.

#### Wireless WAN

A wireless WAN covers a broader geographic area. Cellular networks are used for data transmission, and access is provided by a wireless service carrier.

#### Bluetooth

Bluetooth is one of a number of technologies used to create a wireless personal area network. Bluetooth can connect devices a short distance from one another, and is commonly used for connecting peripheral devices to a computer, transferring data between hand-held devices and a personal computer, or remotely controlling and communicating with devices such as mobile phones.

## WiMAX

This long-range wireless data transmission technology based on the 802.16 standard is expected to provide the user a **last mile** broadband connectivity similar to that provided by cable or ADSL, but without the need to physically connect a cable to the personal computer.

## Establishing wireless LAN connections

Your computer comes with a built-in wireless networking card and a configuration utility to help you make wireless LAN connections and monitor the status of your connection, so that you can stay connected to your network while you are in the office, in a meeting room, or at home, with no need for a wired connection.

### Attention:

- If you carry your computer with the wireless LAN feature into an airplane, check the services with the airline before boarding the airplane.
- If there are restrictions on the use of computers on an airplane with the wireless feature, you need to disable it before boarding. To disable it, refer to the instructions in “Enabling or disabling the wireless feature” on page 36.

You can purchase a wireless networking card as an option. For more information, refer to “Finding ThinkPad options” on page 87.

### Tips for using the wireless LAN feature

- Place your computer so that there are as few obstacles as possible between the wireless LAN access point and the computer.
- For the best connection of the wireless LAN feature, open your computer display to an angle of slightly more than 90 degrees.
- If you use the wireless feature (the 802.11 standard) of your computer simultaneously with a Bluetooth option, data transmission speed can be delayed and the performance of the wireless feature can be degraded.

### Setting up the Wireless LAN connection

To use the built-in wireless network card (the 802.11 standard) to communicate, start the Access Connections program. See “Accessing ThinkVantage applications on the Windows 7 operating system” on page 13.

**Note:** Before you start setting up wireless network connections by using the Access Connections program, obtain a Network Name (SSID) and your encryption information from your network administrator.

## Establishing wireless WAN connections

Wireless Wide Area Network (wireless WAN) enables you to establish wireless connections over remote public or private networks. These connections can be maintained over a large geographical area, such as a city or an entire country, by use of multiple antenna sites or satellite systems maintained by wireless service providers.

Some ThinkPad notebook computers come with a built-in wireless WAN card integrating some wireless WAN technologies, such as 1xEV-DO, HSPA, 3G, GPRS, or LTE. You can connect to the Internet or your company network with the built-in wireless WAN card and the configuration utility to make a wireless WAN connection and monitor its status.

**Note:** Wireless WAN service is provided by authorized service providers in some countries.

To locate the wireless WAN antenna on your computer, see “Location of the UltraConnect™ wireless antennas” on page 152.

To use the wireless WAN feature, start the Access Connections program. For information on how to start the Access Connections program, see “Accessing ThinkVantage applications on the Windows 7 operating system” on page 13.

For maximum performance from your wireless WAN connection, please keep the following best usage guidelines in mind:

- Keep your notebook away from your body.
- Place your notebook on a flat surface and open your computer display to an angle of slightly more than 90 degrees.
- Place your notebook away from concrete or brick walls that may dampen cellular signals.
- Best reception will be available near windows and other locations where cellular phone reception is the strongest.

## Using Bluetooth

Some models are equipped with a Bluetooth card that is compliant to Bluetooth Specification 4.0. You can enable or disable the Bluetooth feature by pressing Fn+F5.

### Sending data to a Bluetooth-enabled device

1. Press Fn+F5 and enable the Bluetooth feature.
2. Right-click the data that you want to send.
3. Select **Send To → Bluetooth**.
4. Select a Bluetooth device and then follow the instructions on the screen.

**Note:** If you use the wireless feature (the 802.11 standard) of your computer simultaneously with a Bluetooth option, data transmission speed can be delayed and the performance of the wireless feature can be degraded.

### Adding a Bluetooth device

1. Press Fn+F5 and enable the Bluetooth feature.
2. Click the **Bluetooth** icon from the Windows notification area and select **Add a Device**.
3. Follow the instructions on the screen to establish the connection.

After you add a Bluetooth device, double click the device from the device list to configure the profiles of that device. For details about supported profiles, see “Wireless related information” on page 151.

For more information about using the Bluetooth feature, refer to the Windows help information system and the Bluetooth help information system.

## Using WiMAX

Some ThinkPad notebook computers come with a built-in wireless LAN card integrating WiMAX technology.

WiMAX, a long-range wireless data transmission technology based on the 802.16 standard, provides you with a “last mile” broadband connectivity similar to that offered by cable or ADSL, but without the need to physically connect a cable to the personal computer.

To use the WiMAX feature, start the Access Connections program.

## Checking wireless connection status





You can check your computer wireless connection status and wireless signal strength through the Access Connections gauge on the taskbar, or through the Access Connections icon and wireless status icon on the taskbar.

### Access Connections gauge



On the Windows 7 operating system, the Access Connections gauge on the taskbar displays the signal strength and status of your wireless connection.

You can find more detailed information about the signal strength and status of your wireless connection by opening the Access Connections program or by right-clicking the Access Connections gauge on the taskbar and selecting **View Status of Wireless Connection**.

- Access Connections gauge states: wireless LAN

-  Power to the wireless radio is off or no signal.
-  Power to the wireless radio is on. The signal strength of the wireless connection is poor. To improve signal strength, move your computer closer to the wireless access point.
-  Power to the wireless radio is on. The signal strength of the wireless connection is marginal.
-  Power to the wireless radio is on. The signal strength of the wireless connection is excellent.

- Access Connections gauge states: wireless WAN

-  No signal
-  Signal level 1
-  Signal level 2
-  Signal level 3



### Access Connections icon and wireless status icon

The Access Connections icon displays general connection status.





The wireless status icon displays the signal strength and status of your wireless connection.









You can find more detailed information about the signal strength and status of your wireless connection either by opening the Access Connections program or by double-clicking the Access Connections wireless status icon on the taskbar.

- Access Connections icon states

-  No location profile is active or none exists.
-  Current location profile is disconnected.
-  Current location profile is connected.

- Wireless status icon states: wireless LAN

-  Power to the wireless radio is off.
-  Power to the wireless radio is on. No association.
-  Power to the wireless radio is on. No signal.
-  Power to the wireless radio is on. The signal strength of the wireless connection is excellent.

-  Power to the wireless radio is on. The signal strength of the wireless connection is marginal.
-  Power to the wireless radio is on. The signal strength of the wireless connection is poor. To improve signal strength, move your system closer to the wireless access point.
- Wireless status icon states: wireless WAN
  -  Power to the WAN radio is off
  -  No association
  -  No signal
  -  Signal level 1
  -  Signal level 2
  -  Signal level 3

**Note:** If you have trouble in making a connection, try moving your computer closer to your wireless access point.

## Enabling or disabling the wireless feature

To enable or disable the wireless features, do one of the following:

- Press Fn+F5 to bring up the wireless feature list, such as wireless LAN and Bluetooth. Select a feature to enable or disable it.
- Click the Access Connections wireless status icon in the Windows notification area. Then, click **Power On Wireless Radio** to enable the wireless features or click **Power Off Wireless Radio** to disable the wireless features.

**Note:** You can use the wireless radio switch to disable the wireless radio of all the wireless devices on your computer.

---

## Presentations and multimedia

You can connect your computer to a projector to give presentations or you can connect your computer to an external monitor to expand your workspace.

## Changing display settings

You can change the display settings, such as the display resolution, font size, and so on.

To change the display settings, do the following:

1. Open Control Panel and click **Appearance and Personalization**.
2. Click **Display** for further configuration.

## Connecting a projector or external display

This topic provides information about connecting a projector or an external monitor.

### Attaching an external monitor

Your computer can support a maximum video resolution of up to 2048x1536 (with an external monitor attached to the VGA connector) or up to 2560x1600 (with an external monitor attached to the Mini DisplayPort connector), provided that the external monitor also supports that resolution. For more details, refer to the manuals provided with your monitor.

You can set any resolution for either the computer display or the external monitor. When you use both at the same time, the resolution of both is the same. If you set a higher resolution for the computer display, you can see only part of the screen at a time. You can see other parts by moving the image with the TrackPoint pointing device or another pointing device.

You can move the display output to the computer display, the external monitor, or both by pressing Fn+F7.

### Connecting an external monitor

To attach an external monitor, do the following:

1. Connect the external monitor to the VGA connector or the Mini DisplayPort connector.
2. Connect the monitor to an electrical outlet.
3. Turn on the external monitor.
4. Change the display output location by pressing Fn+F7. This enables you to switch between viewing output on the external monitor, the computer monitor, and both monitors.

**Note:** If your computer cannot detect the external monitor, right-click on the desktop, then select **Screen resolution**. Click the **Detect** button.

### Setting the external monitor type

To set the external monitor type, do the following:

1. Connect the external monitor to the monitor connector, and then connect the monitor to an electrical outlet.
2. Turn on the external monitor.
3. Right-click on the desktop, and click **Screen resolution**.

**Note:** If your computer cannot detect the external monitor, click the **Detect** button.

4. Select the external monitor and set **Resolution**.
5. Click **Advanced Settings**.
6. Click the **Monitor** tab. Check the monitor information to make sure that the monitor type is correct. If it is, click **OK** to close the window; otherwise proceed with the following steps.
7. If more than two monitor types are displayed, select **Generic PnP Monitor** or **Generic Non-PnP Monitor**.
8. Click **Properties**. If you are prompted for an administrator password or confirmation, type the password or provide confirmation.
9. Click the **Driver** tab.
10. Click **Update Driver**.
11. Click **Browse my computer for driver software**, and then click **Let me pick from a list of device drivers on my computer**.
12. Clear the **Show compatible hardware** check box.
13. Select the correct manufacturer and model for the external monitor. If you cannot find your monitor on the list, stop the installation of this driver and use the driver shipped with your monitor.
14. After updating the driver, click **Close**.
15. Click **OK**.

### Changing the color quality of the external monitor

To change the color quality of the external monitor, do the following:

1. Attach and turn on the external monitor.

2. Right-click on the desktop, and click **Screen resolution**.

**Note:** If your computer cannot detect the external monitor, click the **Detect** button.

3. Select the external monitor and click **Advanced Settings**.
4. Click the **Monitor** tab and select a color value from the **Colors** field.
5. Click **OK**.

### Considerations for attaching an external monitor

- When installing an operating system, you must install the display driver for your monitor that is supplied with the computer, and the monitor INF file that is supplied with the external monitor.
- If you set a resolution higher than the resolution you are using on the computer monitor, and use an external monitor that does not support that resolution, take advantage of the virtual screen function, which enables you to display only a part of the high-resolution screen image your computer produces. You can see other parts of the image by moving the screen with the TrackPoint pointing device or another pointing device.
- If the external monitor you are using is outdated, the resolution and the refresh rate might be limited.

### Using the DVI monitor

If your computer is attached to one of the following optional expansion units, you can connect a digital visual interface (DVI) monitor to your computer through the DVI connector of that unit.

- ThinkPad Mini Dock Series 3
- ThinkPad Mini Dock Series 3 with USB 3.0
- ThinkPad Mini Dock Plus Series 3
- ThinkPad Mini Dock Plus Series 3 with USB 3.0

#### Notes:

- The screen mode that can be used depends on the specifications of the DVI monitor.
- Before you attach the DVI monitor, make sure that the computer is attached to the expansion unit and the system works properly.

To attach the DVI monitor, do the following:

1. Turn off the computer.
2. Connect the DVI monitor to the DVI connector of the expansion unit, and then connect the monitor to an electrical outlet.
3. Turn on the DVI monitor and the computer. The system starts.

If the computer output does not appear on the DVI monitor, do the following:

1. Press Ctrl+Alt+F12. The Intel Graphics and Media Control Panel window opens.
2. Select **Advanced Mode** and click **OK**.
3. Select **Multiple Displays**.
4. In the **Operating Mode** field, select any of the following options.
  - **Single Display:** Depending on your configuration, the computer output is displayed on either the computer display or the DVI monitor.
  - **Clone Displays:** The same computer output is displayed on both the computer display and the DVI monitor.
  - **Extended Desktop:** Different computer output is displayed on the computer display and the DVI monitor.



## Considerations for attaching a DVI monitor

Connect the DVI monitor to the expansion unit, and turn it on before you turn on the computer. Otherwise the system cannot recognize the DVI monitor. If the option for enabling the DVI monitor in the Display Properties window is not displayed, try closing the window and opening it again. If the option still is not displayed, make sure that the connector of the monitor is attached firmly, and repeat the procedure for attaching the monitor.

## Using the Mini DisplayPort connector

Your computer has a Mini DisplayPort connector, a digital display interface for connection to various external devices, such as CRT monitors, LCD monitors, projectors, or even high-definition televisions. This compact connector enables a plug-and-play setup and supports adapters that can plug into DVI, VGA, or HDMI connectors.

The Mini DisplayPort connector of your computer supports audio as well as video streaming.

## Setting up a presentation

To display information and make presentations, you can attach a data projector to your computer through the VGA connector on your computer.

**Note:** It may take several seconds before the projector displays the image. If you do not see your desktop displayed after 60 seconds, try pressing Fn+F7 to switch between different display output locations.

Your projector might have one or more audio-input connectors. To project sound, you will need to attach the combo audio jack on your computer to these connectors, using an audio cable (commercially available).

## Using the Extend desktop function

Your computer supports a function named the Extend desktop function. With the Extend desktop function, you can display output on both the computer display and an external monitor. You also can display different desktop images on each monitor.

### Considerations for using the Extend desktop function

- When an application using DirectDraw or Direct3D is played in full-screen mode, it is shown only on the primary display.
- If you want to show DOS full-screen while in the Extend desktop mode, only the primary display shows DOS; the other display is blacked out.
- If your computer has the Intel graphics card, you can designate the other display as the primary display by doing the following:
  1. Press Ctrl+Alt+F12. The Intel Graphics and Media Control Panel window opens.
  2. Select **Advanced Mode** and click **OK**.
  3. Click **Multiple Display**.
  4. Select the desired display as the primary display.

### Enabling the Extend desktop function

To enable the Extend desktop function, do the following:

1. Connect the external monitor to the monitor connector; then connect the monitor to an electrical outlet.
2. Turn on the external monitor.
3. Press Fn+F7, then select **Extend**.

To change the resolution and color quality for each monitor, do the following:

1. Right-click on the desktop, and click **Screen resolution**.
2. Click the monitor-1 icon (for the primary display, the computer display).
3. Set the resolution for the primary display.
4. Click the monitor-2 icon (for the secondary display, the external display).
5. Set the resolution for the secondary display.
6. Click **Advanced settings** and set up the color quality on the **Monitor** tab.
7. Click **OK** to apply the changes.

## Using audio features

Your computer is equipped with the following:

- Combo audio jack, 1/8 inch (3.5 mm) in diameter
- Built-in speakers
- Built-in microphones

Your computer also has an audio chip that enables you to enjoy various multimedia audio features, such as the following:

- Recording and playback of PCM and WAV files
- Playback of MIDI and MP3 files
- Recording from various sound sources, such as a headset attached

The following table shows which functions of the audio devices attached to the jacks on your computer or docking station are supported.

*Table 3. Audio feature list*

Jack	Headset with a 3.5 mm 4-pole plug	Conventional headphone	Conventional microphone
Combo audio jack	Headphone and microphone functions supported	Headphone function supported	Not supported
Headphone jack of the docking station	Only headphone function supported  Microphone function not supported	Headphone function supported	Not supported
Microphone jack of the docking station	Not supported	Not supported	Microphone function supported

To configure the microphone for optimized sound recording on the Windows 7 operating system, use the Realtek HD Audio Manager program. To start the program, click **Start → Control Panel → Hardware and Sound → Realtek HD Audio Manager**.

## Using the integrated camera

If your computer has an integrated camera, when you press Fn+F6 to open the Communications Settings window, the camera will be launched and the green camera-in-use indicator will turn on automatically. In the Communications Settings window, you can preview your video image and take a snapshot of your current image.

You also can use the integrated camera with other programs that provide features such as photographing, video capturing, and video conferencing. To use the integrated camera with other programs, open one of the programs and start the photographing, video capturing, or video conferencing function. Then, the camera will start automatically and the green camera-in-use indicator will turn on. For more information about using the camera with a program, refer to the help information system of the program.

If you do not want the camera to be launched automatically when you press Fn+F6 or when you use a program, press Fn+F6 to open the Communications Settings window and click the **Hide my video image** button to disable the camera.

### Configuring camera settings

Configure the camera settings to meet your needs, such as adjusting the quality of the video output.

To configure the camera settings, do the following:

1. Press Fn+F6. The Communications Settings window opens.
2. Click the **Manage Settings** button. The Communications Utility window opens.
3. In the Communications Utility window, configure the camera settings depending on your individual needs.

### Adjusting the video output quality of your camera

To adjust the quality of the video output of your camera, do the following:

1. Open the Communications Utility window.
2. Click **Advanced camera settings**. The Properties window opens.
3. Configure the settings and select an image quality value. The following values are available:
  - **Speed Priority:** It gives you a faster frame rate for the best real-time video conferencing during the day. However, at night or in a dark environment, the image does not have the best quality.
  - **Balance:** This gives you a balance between speed and image quality. The image obtained at night or in a dark environment is better than with Speed Priority.
  - **Image quality priority:** This gives you a high-quality video and the best image at any time of the day. The image is very clear even at night or in a dark environment, but at the expense of frame rate. The video streaming might slow down.

### Using the Lenovo AutoLock function

To help protect against unauthorized use, the Lenovo AutoLock function enables the computer to lock automatically when the integrated camera cannot detect any facial feature after the computer is left unattended for a while.

To use this function, open Control Panel and click **System and Security → Lenovo - Camera-enhanced security**. Then enable the function and configure the settings by following the instructions on the screen.

---

## Using an ExpressCard, a flash media card, or a smart card

Depending on the model, your computer might have the following card slots:

- An ExpressCard slot that supports:
  - 54 mm-wide ExpressCard
  - Smart card
- A 4-in-1 media card reader slot that supports:
  - SD card

- SDHC card
- SDXC card
- MultiMediaCard (MMC)

**Notes:**

- Your computer does not support the CPRM feature for the SD card.
- While transferring data to or from a flash media card, such as an SD card, do not put your computer into sleep or hibernation mode before the data transfer is complete; otherwise, your data could become damaged.

**Installing an ExpressCard, a flash media card, or a smart card**

**Attention:** Before you start installing a card, touch a metal table or a grounded metal object. This action reduces any static electricity from your body. The static electricity could damage the card.

To install an ExpressCard or a flash media card, do the following:

1. Locate the appropriate type of slot for your card. See “Locating computer controls, connectors, and indicators” on page 1.
2. Make sure that the card is correctly oriented:
  - For ExpressCard: The notched edge of the card is facing upward and pointing toward to the card slot.
  - For flash media card: The metal contacts are facing downward and pointing toward the card slot.
3. Press the card firmly into the card slot.

To install a smart card, do the following:

1. Locate the 54 mm-wide ExpressCard slot. See “Locating computer controls, connectors, and indicators” on page 1.
2. Install the smart card into a 54 mm smart card reader. You can purchase a 54 mm smart card reader from Lenovo.
3. Insert the smart card reader into the ExpressCard slot firmly.

If the plug-and-play feature is not enabled for the installed ExpressCard, flash media card, or smart card, do the following to enable the feature:

1. Open Control Panel.
2. Click **Hardware and Sound**.
3. Click **Device Manager**. If you are prompted for an administrator password or confirmation, type the password or provide confirmation.
4. From the **Action** menu, select **Add legacy hardware**. The Add Hardware Wizard starts.
5. Follow the instructions on the screen.

**Removing an ExpressCard, a flash media card, or a smart card**

**Attention:** Before removing a card, stop the card first. Otherwise, data on the card might be corrupted or lost.

To remove a card, do the following:

1. Click the triangular icon on the taskbar to show hidden icons. Then, right-click the **Safely Remove Hardware and Eject Media** icon.
2. Select the item you want to remove to stop the card.
3. Press the card to eject it from your computer.
4. Remove the card and store it safely for future use.

**Note:** If you do not remove the card from your computer after you eject the card from the Windows operating system, the card can no longer be accessed. To access the card, you must remove it first, then insert it again.



---

## Chapter 3. You and your computer

This chapter provides information about accessibility, comfort, and travelling with your computer.

- “Accessibility and comfort” on page 45
- “Traveling with your computer” on page 47

---

### Accessibility and comfort

Good ergonomic practice is important to get the most from your personal computer and to avoid discomfort. Arrange your workplace and the equipment you use to suit your individual needs and the kind of work that you perform. In addition, use healthy work habits to maximize your performance and comfort while using your computer.

The following topics provide information about arranging your work area, setting up your computer equipment, and establishing healthy work habits.

Lenovo is committed to providing the latest information and technology to our customers with disabilities. Refer to our accessibility information which outlines our efforts in this area.

### Ergonomic information

Working in the virtual office might mean adapting to frequent changes in your environment. Following some simple rules will make things easier and bring you the maximum benefits of your computer. Keeping in mind such basics as good lighting and proper seating, for example, can help you improve your performance and achieve greater comfort.

This example shows someone in a conventional setting. Even when not in such a setting, you can follow many of these tips. Develop good habits, and they will serve you well.

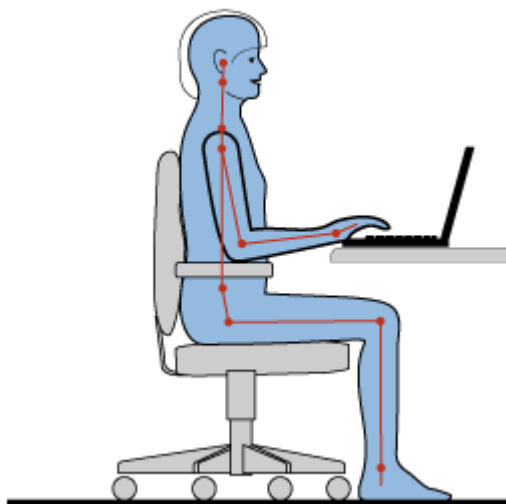

**General posture:** Make minor modifications in your working posture to deter the onset of discomfort caused by long periods of working in the same position. Frequent, short breaks from your work also help to prevent minor discomfort associated with your working posture.

**Display:** Position the display to maintain a comfortable viewing distance of 510-760 mm (20-30 inches). Avoid glare or reflections on the display from overhead lighting or outside sources of light. Keep the display screen clean and set the brightness to levels that enable you to see the screen clearly. Press Fn+F8 or Fn+F9 to adjust display brightness.

**Head position:** Keep your head and neck in a comfortable and neutral (vertical, or upright) position.

**Chair:** Use a chair that gives you good back support and seat height adjustment. Use chair adjustments to best suit your desired posture.

**Arm and hand position:** If available, use chair arm rests or an area on your working surface to provide weight support for your arms. Keep your forearms, wrists, and hands in a relaxed and neutral (horizontal) position. Type with a soft touch without pounding the keys.

**Leg position:** Keep your thighs parallel to the floor and your feet flat on the floor or on a footrest.

### ***What if you are traveling?***

It might not be possible to observe the best ergonomic practices when you are using your computer while on the move or in a casual setting. Regardless of the setting, try to observe as many of the tips as possible. Sitting properly and using adequate lighting, for example, will help you maintain desirable levels of comfort and performance.

### ***Questions about vision?***

The visual display screens of ThinkPad notebook computers are designed to meet the highest standards and to provide you with clear, crisp images and large, bright displays that are easy to see, yet easy on the eyes. Of course, any concentrated and sustained visual activity can be tiring. If you have questions on eye fatigue or visual discomfort, consult a vision care specialist for advice.

## **Comfort**

Observe the following guidelines to achieve greater comfort and improve performance.

**Active sitting and rest breaks:** The longer you sit and work with your computer, the more important it is to observe your working posture. Follow “Ergonomic information” on page 45 and practice “active sitting” to avoid discomfort associated with your working postures. Making minor voluntary postural changes and taking short frequent work breaks are the key ingredients for healthy computing. Your computer is light and mobile; you can easily reposition your working surface to accommodate many posture modifications.

**Work area setup options:** Familiarize yourself with all of your office furniture so that you know how to adjust your work surface, seat, and other work tools to accommodate your preferences for comfort. If your work area is not in an office setting, be sure to take special note of employing active sitting and taking work breaks. Many ThinkPad product solutions are available to help you modify and expand your computer to best suit your needs. Access the following Web site to view some of these options: <http://www.lenovo.com/accessories/services/index.html>. Explore your options for docking solutions and external products that provide the adjustability and features that you want.

## **Accessibility information**

Lenovo is committed to providing people with disabilities greater access to information and technology. As a result, the following information provides ways to help users that have hearing, vision, and mobility limitations get the most out of their computer experience.



Assistive technologies enable users to access information in the most appropriate way. Some of these technologies are already provided in your operating system. Others can be purchased through vendors, or accessed through the World Wide Web <http://www.lenovo.com/healthycomputing>.

## Assistive technologies

Some accessibility technologies are available through the Accessibility Options program. Depending on your operating system, the number of accessibility options available varies. In general, accessibility options enhance the way users with hearing, vision, or mobility limitations navigate and use their computer. For example, some users might not have the fine motor skills required to use a mouse or select key combinations. Other users might require larger fonts or high-contrast display modes. In some cases, magnifiers and built-in speech synthesizers are available. For detailed information about each of these features, consult the Microsoft help information system.

To use the Accessibility Options program, click **Start → Control Panel → Ease of Access → Ease of Access Center**.

## Screen reader technologies

Screen reader technologies are primarily focused on software application interfaces, help information systems, and a variety of online documents. However, in the case where a screen reader cannot read documents, the document must first go through a conversion process. One solution converts Adobe PDF files into a format that is read by the screen-reader programs. This solution is a Web-based service provided by Adobe Systems Incorporated. Through <http://access.adobe.com>, Adobe PDF documents can be converted to HTML or plain text in many languages. One conversion option converts PDF documents on the Internet. A second option enables users to submit the URL of an Adobe PDF file through e-mail to convert it to HTML or ASCII text. Adobe PDF files on a local hard disk drive, local CD-ROM, or LAN also can be converted by attaching the Adobe PDF file to an e-mail message.

---

## Traveling with your computer

This topic provides information to help you work with your computer when you are travelling.

### Travel tips

Use the following travel tips to travel more confidently and efficiently with your computer.

- Although it is safe to allow your computer to go through the x-ray machines at airport security stations, it is important to keep your eyes on the computer at all times to prevent theft.
- Consider bringing an electrical adapter for use in an airplane or automobile.
- If you carry an ac power adapter, detach the ac cord from it to avoid damaging the cord.

### Travel tips on airplanes

If you carry your computer into an airplane, take note of the following tips:

- If you intend to use your computer or wireless services (such as Internet and Bluetooth), check with the airline for restrictions and availability of services before boarding the airplane. If there are restrictions on the use of computers with wireless features on the airplane, you must abide by those restrictions. If necessary, disable wireless features before boarding.
- Be careful about the seat in front of you on airplanes. Angle your computer display so that it does not get caught when the person in front of you leans back.
- When taking off, remember to turn off your computer or put it into hibernation mode.

## Travel accessories

The following is a checklist of items to consider packing when you are going to travel:

- ThinkPad ac power adapter
- ThinkPad AC/DC Combo Adapter
- External mouse, if you are accustomed to using one
- Ethernet cable
- Extra battery, charged
- A quality carrying case that provides adequate cushion and protection
- External storage device

If you are traveling to another country, you might want to consider an ac power adapter for the country to which you are travelling.

To purchase travel accessories, go to <http://www.lenovo.com/accessories>.

---

## Chapter 4. Security

This chapter provides information about how to protect your computer from theft and unauthorized use.

- “Attaching a mechanical lock” on page 49
- “Using passwords” on page 49
- “Hard disk security” on page 54
- “Setting the security chip” on page 55
- “Using the fingerprint reader” on page 56
- “Notice on deleting data from your hard disk drive or solid state drive” on page 59
- “Using firewalls” on page 60
- “Protecting data against viruses” on page 60

---

### Attaching a mechanical lock

You can attach a mechanical lock to your computer, to help prevent it from being removed without your permission.

Attach a mechanical lock to the keyhole of the computer; then secure the chain on the lock to a stationary object. Refer to the instructions shipped with the mechanical lock.

**Note:** You are responsible for evaluating, selecting, and implementing the locking device and security feature. Lenovo makes no comments, judgments, or warranties about the function, quality, or performance of the locking device and security feature.

---

### Using passwords

By using passwords, you can help prevent your computer from being used by others. Once you set a password, a prompt is displayed on the screen each time you turn on the computer. Enter your password at the prompt. You cannot use the computer unless you type the correct password.

### Passwords and sleep mode

If you have set a Windows password and you put your computer into sleep mode by pressing Fn+F4, you will be prompted to enter the password when resuming operation.

If any hard disk drive or solid state drive also has a password, it is unlocked automatically when you resume operation.

### Typing passwords



If this icon is displayed, type a power-on password or a supervisor password.



If this icon is displayed, type a user hard disk password. If you want to type a master hard disk password, do the following:

1. Press F1. The icon changes to this: 

2. Type the master hard disk password.

**Note:** To return to the icon , press F1 again.



If this icon is displayed, type a supervisor password.

**Note:** Press the Backspace key if you enter a wrong password while you are typing your password.

## Power-on password

You can set a power-on password to help protect your computer against access by unauthorized users.

If you set a power-on password, the password prompt is displayed on the screen whenever you turn on the computer. You must enter the correct password to start using the computer.

### Setting a power-on password

1. Print these instructions.
2. Save all open files, and exit all applications.
3. Turn your computer off and then turn it on again.
4. When the logo screen is displayed, press F1. The ThinkPad Setup program main menu opens.
5. Select **Security**, using the cursor directional keys to move down the menu.
6. Select **Password**.
7. Select **Power-on Password**.
8. In the **Enter New Password** field, type a desired password, and press Enter.
9. In the **Confirm New Password** field, retype the password and press Enter.

**Note:** You might want to note down your power-on password in a safe place. Otherwise, if you forget it, you have to take your computer to a Lenovo reseller or a marketing representative to have the password canceled.

10. In the Setup Notice window that is displayed, press Enter to continue.
11. Press F10. The Setup Confirmation window opens. Select **Yes** to save configuration changes and exit.

### Changing or removing the power-on password

To change the power-on password, follow steps 1 through 7 as introduced above. Enter your current password. When the **Enter New Password** field is displayed, type a new password in the field and then retype it to verify. To remove the password, follow steps 1 through 7. Type your current password. When the **Enter New Password** field is displayed, leave it blank and press Enter twice.

## Hard disk passwords

Two types of hard disk passwords help protect the information stored on the hard disk drive or solid state drive:

- User hard disk password
- Master hard disk password, which requires a user hard disk password

If a user hard disk password has been set, but no master hard disk password has been, the user must enter the user hard disk password in order to gain access to files and applications on the hard disk drive.

The master password can be set and used only by a system administrator. Like a master key, it enables the administrator to get access to any hard disk drive in a system. The administrator sets the master password; no one else knows it. Then the administrator sets a user password for each computer in the network, and tells each user the password for his or her computer. The user can then change the user password as desired, but the administrator still can get access by using the master password.

**Note:** When a master hard disk password is set, only the administrator can remove the user hard disk password.

### Setting a hard disk password

1. Print these instructions.
2. Save all open files, and exit all applications.
3. Turn off your computer and then turn on again.
4. When the logo screen is displayed, press F1. The ThinkPad Setup program main menu opens.
5. Select **Security**, using the cursor directional keys to move down the menu.
6. Select **Password**.
7. Select **Hard Disk 1 Password**.
8. A password window opens. You are prompted to select **User** or **User+Master**. Select **User** if you want to set only one hard disk password. If you are an administrator or supervisor, select **User+Master** to set two passwords. (The user can change the user password later.)

- If you select **User** only, do the following:
  - a. When a window for typing the new password opens, type your new password in the **Enter New Password** field. Press Enter.

#### Notes:

- You can set the minimum length of a hard disk password through **Set Minimum Length** on the **Security** menu.
  - If you set a hard disk password of over seven characters, the hard disk drive can be used only with a computer that can recognize a hard disk password of over seven characters. If you then install the hard disk drive in a computer that cannot recognize a hard disk password that contains more than seven characters, you cannot get access to the drive.
- b. In the Confirm New Password field, retype the password you just entered to verify it. Press Enter.
- If you select **User+Master**, do the following:
    - a. When a window for typing the new user hard disk password opens, type your new password in the **Enter New Password** field. Press Enter.
    - b. In the **Confirm New Password** field, retype the password you just entered to verify it. Press Enter.
    - c. A message window opens and prompts you to set the master hard disk password. Press Enter to continue.
    - d. A window for typing the new master hard disk password opens. Type your new password in the **Enter New Password** field. Press Enter.
    - e. In the **Confirm New Password** field, retype the password you just entered to verify it. Press Enter.

**Attention:** You might want to note down your passwords and keep them in a safe place. Otherwise, if you forget the user password, or both user and master passwords, Lenovo cannot reset your passwords or recover data from the hard disk drive. You must take your computer to a Lenovo reseller or a marketing representative to have the hard disk drive replaced. Proof of purchase is required, and a fee will be charged for parts and service.

9. In the Setup Notice window that is displayed, press Enter to continue.

10. Press F10. The Setup Confirmation window opens. Select **Yes** to save configuration changes and exit.

The next time you turn on your computer, you will have to type the user or master hard disk password in order to start your computer and get access to your operating system.

### Changing or removing a hard disk password

To change or remove the user hard disk password, do the following:

1. Follow steps 1 through 7 in “Setting a hard disk password” on page 51.

**Note:** You need to type your password to get access to the ThinkPad Setup program.

2. Select **User HDP** and then do either of the following:
  - To change the user hard disk password, type the current password in the **Enter Current Password** field. Then type the new password in the **Enter New Password** field, and retype the password you just entered to verify it in the **Confirm New Password** field. Press Enter, and a Setup Notice window is displayed. Press F10 to exit from the Setup Notice window. The user hard disk password will be changed.
  - To remove the user hard disk password, type the current password in the **Enter Current Password** field. Then leave the **Enter New Password** and **Confirm New Password** fields blank, and press Enter. A Setup Notice window is displayed. Press F10 to exit from the Setup Notice window. The user hard disk password will be removed.

To change or remove the master hard disk passwords, do the following:

1. Follow steps 1 through 7 in “Setting a hard disk password” on page 51.

**Note:** You need to type your password to get access to the ThinkPad Setup program.

2. Select **Master HDP** and then do either of the following:
  - To change the master hard disk password, type the current master hard disk password in the **Enter Current Password** field. Then type the new master hard disk password in the **Enter New Password** field, and retype the password you just entered to verify it in the **Confirm New Password** field. Press Enter, and a Setup Notice window is displayed. Press F10 to exit from the Setup Notice window. The master hard disk password is changed.
  - To remove the master hard disk password, type the current master hard disk password in the **Enter Current Password** field. Then leave the **Enter New Password** and **Confirm New Password** fields blank, and press Enter. A Setup Notice window is displayed. Press F10 to exit from the Setup Notice window. Both the user and master hard disk passwords will be removed.

## Supervisor password

The supervisor password protects the system information stored in ThinkPad Setup. No one can change the computer configuration without the supervisor password. It provides the following security features:

- If a supervisor password is set, a password prompt is displayed when you try to start the ThinkPad Setup program. Unauthorized users cannot get access to configuration data.
- The system administrator can use the supervisor password to get access to a computer even if the user of that computer has set a power-on password. The supervisor password overrides the power-on password.
- If both a supervisor password and a power-on password are set, you can do the following only if you have the supervisor password:
  - Deleting the power-on password
  - Changing or deleting the supervisor password
  - Enabling or disabling the Wake on LAN feature

- Enabling or disabling the Internal Network Option ROM feature
- Changing date and time
- Enabling or disabling the Lock UEFI BIOS Settings feature
- Enabling or disabling the Password at unattended boot feature
- Specifying the minimum length for power-on passwords and hard disk passwords
- Changing the setting for the security chip
- Enabling or disabling the Boot Device List F12 Option feature
- Enabling or disabling the Boot Order Lock feature
- Enabling or disabling the Flash BIOS Updating by End-Users feature
- Enabling or disabling the internal network device
- Enabling or disabling the internal wireless device
- Enabling or disabling the internal Bluetooth device
- Enabling or disabling the internal wireless WAN device
- Enabling or disabling the Security mode
- Enabling or disabling the fingerprint reader priority
- Erasing the fingerprint data

**Notes:**

- The system administrator can set the same supervisor password on many ThinkPad notebook computers to make administration easier.
- By enabling the Lock UEFI BIOS Settings feature on the **Password** menu and setting the supervisor password, you make it impossible for anyone but you to make configuration changes.

**Setting, changing, or removing a supervisor password**

Only a system administrator can set, change, or remove a supervisor password.

To set, change, or remove a supervisor password, do the following:

1. Print these instructions.
2. Save all open files, and exit all applications.
3. Turn your computer off and then turn it on again.
4. When the logo screen is displayed, press F1. The ThinkPad Setup program main menu opens.
5. Select **Security**, using the cursor directional keys to move down the menu.
6. Select **Password**.
7. Select **Supervisor Password**.
8. A window opens, prompting you to enter a new password. Depending on your needs, do one of the following:
  - To set a password, do the following:
    - a. In the **Enter New Password** field, type a desired password and press Enter.
    - b. In the **Confirm New Password** field, retype the password and press Enter.
  - To change a password, do the following:
    - a. In the **Enter Current Password** field, type the current supervisor password and press Enter.
    - b. In the **Enter New Password** field, type the new supervisor password; then retype the password you just entered to verify it in the **Confirm New Password** field.

- To remove a password, do the following:
  - a. In the **Enter Current Password** field, type the current supervisor password and press Enter.
  - b. Leave the **Enter New Password** and **Confirm New Password** fields blank. Press Enter.

**Attention:** You might want to note down your password and keep it in a safe place. If you forget your supervisor password, Lenovo cannot reset your password. You must take your computer to a Lenovo reseller or a Lenovo marketing representative to have the system board replaced. Proof of purchase is required, and a fee will be charged for parts and service.

9. In the Setup Notice window that is displayed, press Enter to continue.
10. Press F10. The Setup Confirmation window opens. Select Yes to save configuration changes and exit.

The next time you open the ThinkPad Setup program, you will be prompted to type your password to proceed.

---

## Hard disk security

To protect passwords from unauthorized security attacks, several of the latest technologies and algorithms are integrated into UEFI BIOS and hardware design of ThinkPad notebook computers.

To maximize security, do the following:

1. Set a power-on password as well as a hard disk password for your internal solid state drive or hard disk drive. Refer to the procedures in “Power-on password” on page 50 and “Hard disk passwords” on page 50. For security, a longer password is recommended.
2. To provide reliable security for UEFI BIOS, use the security chip and a security application with a Trusted Platform Module management feature. Refer to “Setting the security chip” on page 55.

**Note:** Microsoft Windows 7 supports TPM management feature.

3. If a Disk Encryption hard disk drive and Encryption solid state drive is installed in your computer, be sure to protect the contents of your computer memory from unauthorized access by use of drive encryption software, such as Microsoft Windows BitLocker® Drive Encryption, which is supported in the Ultimate and Enterprise editions of the Windows 7 operating system. See “Using Windows BitLocker Drive Encryption” on page 54.
4. Before you dispose of, sell, or hand over your computer, make sure to delete data stored on it. See “Notice on deleting data from your hard disk drive or solid state drive” on page 59.

### Using Windows BitLocker Drive Encryption

To help protect your computer against unauthorized access, be sure to use drive encryption software, such as Windows BitLocker Drive Encryption.

Windows BitLocker Drive Encryption is an integral security feature of Windows 7. It is supported in the Ultimate and Enterprise editions of the Windows 7 operating system. It can help you protect the operating system and data stored on your computer, even if your computer is lost or stolen. BitLocker works by encrypting all user and system files, including the swap and hibernation files.

BitLocker uses a Trusted Platform Module to provide enhanced protection for your data and to ensure early boot component integrity. A compatible TPM is defined as a V1.2 TPM.

To check the BitLocker status (Windows 7 only), click **Start → Control Panel → System and Security → BitLocker Drive Encryption**.

For details about Windows BitLocker Drive Encryption, see the Windows 7 help information system, or search for “Microsoft Windows BitLocker Drive Encryption Step-by-Step Guide” on the Microsoft Web site.



## Disk Encryption hard disk drive and Encryption solid state drive

Some models contain the Disk Encryption hard disk drive or Encryption solid state drive. This feature helps to protect your computer against security attacks on media, NAND flash or device controllers by use of a hardware encryption chip. For the efficient use of the encryption feature, be sure to set a hard disk password for the internal storage device.

---

## Setting the security chip

Strict security requirements are imposed on network client computers that transfer confidential information electronically. Depending on the options you ordered, your computer might have an embedded security chip, a cryptographic microprocessor. With the security chip and Client Security Solution, you can do the following:

- Protect your data and system
- Strengthen access controls
- Secure communications

### Setting the security chip

The choices offered on the **Security Chip** submenu under the **Security** menu of ThinkPad Setup are as follows:

- **Security Chip:** activate, inactivate, or disable the security chip.
- **Security Reporting Options:** enable or disable each security reporting option.
- **Clear Security Chip:** clear the encryption key.

### Notes:

- Be sure that the supervisor password has been set in ThinkPad Setup. Otherwise anyone can change the settings for the security chip.
- If you are using Client Security Solution, handle the security chip by doing the following:
  - Do not clear the security chip. If you do, the functions assigned to the keys will be erased.
  - Do not disable the security chip. If you do, Client Security Solution will not work.
- If the security chip is removed or replaced, or a new one has been added, the computer will not start. You will hear four cycles of four beeps each.
- If the security chip is inactive or disabled, the **Clear Security Chip** option will not be displayed.
- When you clear the security chip, be sure to turn your computer off and then turn it on again after you set the security chip to **Active**. Otherwise, the **Clear Security Chip** option is not displayed.

To set an item on the **Security Chip** submenu, do the following:

1. Print these instructions.
2. Save all open files, and exit all applications.
3. Turn your computer off and then turn it on again.
4. When the logo screen is displayed, press F1. The ThinkPad Setup program main menu opens.
5. Using the cursor keys, move to **Security**. The **Security** menu opens.
6. Using the cursor keys, move to **Security Chip**, and press Enter. The **Security Chip** submenu opens.
7. Using the cursor keys, move to an item you want to set. When the item is highlighted, press Enter.
8. Set other items that you want to set.
9. Press F10 to save changes and exit.
10. Press Enter in the Setup Confirmation window to confirm the exit.

To set the security chip, you have to start Client Security Solution, and follow the instructions on the screen.

**Note:** Client Security Solution is not preinstalled on Windows 7 models. To configure the security chip, you need to download the latest version of Client Security Solution from the Lenovo Web site. To download Client Security Solution, go to <http://www.lenovo.com/support>. Then follow the instructions on the screen.

---

## Using the fingerprint reader

Depending on the options you ordered, your computer might have an integrated fingerprint reader. By enrolling your fingerprint and associating it with a power-on password, a hard disk password, or both passwords beforehand, you can start the computer, log on to the system, and enter ThinkPad Setup by swiping your finger over the reader, without typing a password. Thus fingerprint authentication can replace passwords and enable simple and secure user access.

For more advanced security, Client Security Solution can be installed. The software is compatible with a variety of user authentication mechanisms, such as those involving fingerprint authentication. This fingerprint reader can work with the software.

**Note:** Client Security Solution is not preinstalled on Windows 7 models. You can download it from the Lenovo Support Web site at <http://www.lenovo.com/support>.

### Enrolling your fingerprint

1. Turn on your computer.
2. To start Lenovo Fingerprint software, refer to “Accessing ThinkVantage applications on the Windows 7 operating system” on page 13.
3. Follow the instructions on the screen to enroll your fingerprint. For details, refer to the Help for the program.

### LED behavior of the fingerprint reader



Table 4. LED behavior list\_fingerprint reader

LED behavior	Description
Steady green	The fingerprint reader is ready to swipe.
Blinking green once	The fingerprint is being authenticated or has been authenticated.
Blinking green	The fingerprint reader is ready to swipe in power-on authentication state.
Blinking amber	The fingerprint could not be authenticated.
Steady amber for 15 seconds	The power-on authentication feature is disabled after three bad fingerprint swipes.

### Swiping your finger over the reader

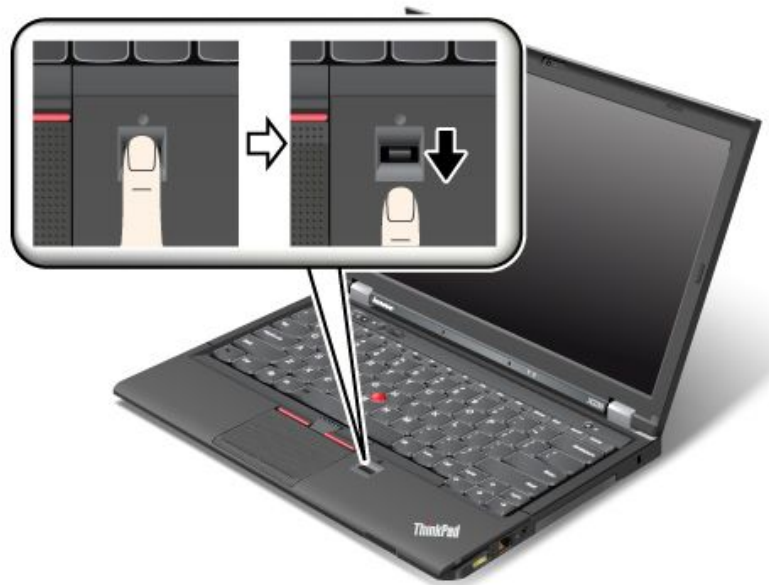

To swipe your finger over the reader, place the ball of your finger, that is, the central part of the fingerprint, on the small circle above the reader. Make sure that the entire top joint of the finger is on the reader. Then Apply light pressure and swipe your finger across the reader in one smooth motion.

### Logging on to the system

After you enroll your fingerprint, log on to the system by doing the following:

1. Set a power-on password or a hard disk password, or both.
2. Turn your computer off and then on again.
3. When prompted, swipe your finger over the reader.
4. On request, type your power-on password, your hard disk password, or both. The enrolled fingerprint is now associated with your power-on password, your hard disk password, or both.

The next time you start the computer, you can log on to the system by swiping your finger over the reader once.

**Attention:** If you always use your fingerprint to log on to the system, you might forget your password. Write down your password, and keep it in a safe place. If you forget it and for some reason you cannot swipe your finger across the reader, for example, if you injure that finger, you cannot start the computer or change the password. If you forget your power-on password, you must take your computer to a Lenovo authorized servicer or a marketing representative to have the password canceled.

If you forget your hard disk password, Lenovo cannot reset your password or recover data from the hard disk. You must take your computer to a Lenovo authorized servicer or a marketing representative to have the hard disk drive replaced. Proof of purchase is required, and a fee will be charged for parts and service.

### Setting the fingerprint reader

If you want to change the settings of the fingerprint reader, follow the procedure below.

The fingerprint submenu under the Security menu of ThinkPad Setup offers the following choices:

- **Predesktop Authentication:** Enable or disable fingerprint authentication before the operating system is loaded.
- **Reader Priority:** Define the priority for fingerprint readers if an external fingerprint reader is attached.
- **Security Mode:** Specify the settings of the security mode.
- **Password Authentication:** Enable or disable password authentication.

**Note:** This item appears if High security mode is selected.

- **Reset Fingerprint Data:** By choosing this item, you can erase all of the fingerprint data stored in either the internal or external fingerprint reader.

To set an item in the fingerprint submenu:

1. Print these instructions. To configure the fingerprint reader, you must turn your computer off and then on again.
2. Save all open files, and exit all applications.
3. Turn your computer off and then on again.
4. When the logo screen is displayed, press F1. The ThinkPad Setup program main menu opens.
5. Using the cursor keys, move to **Security**, and press Enter. The Security menu opens.
6. Using the cursor keys, move to **Fingerprint**, and press Enter. The Fingerprint submenu opens.
7. Using the cursor keys, move to an item you want to set. When that item is highlighted, press Enter.
8. Set the items you want to set.
9. Press F10 to exit.
10. In the Setup Confirmation window, select **Yes**.

### Care for the fingerprint reader

The following actions could damage the fingerprint reader or cause it not to work properly:

- Scratching the surface of the reader with a hard, pointed object.
- Scraping the surface of the reader with your fingernail or anything hard.
- Using or touching the reader with a dirty finger.

If you notice any of the following conditions, gently clean the surface of the reader with a dry, soft, lint-free cloth:

- The surface of the reader is dirty or stained.
- The surface of the reader is wet.
- The reader often fails to enroll or authenticate your fingerprint.

If your finger has any of the following conditions, you might not be able to register or authenticate it:

- Your finger is wrinkled.
- Your finger is rough, dry, or injured.

- Your finger is very dry.
- Your finger is stained with dirt, mud, or oil.
- The surface of your finger is very different from when you enrolled your fingerprint.
- Your finger is wet.
- A finger is used that has not been enrolled.

To improve the situation, try the following:

- Clean or wipe your hands to remove any excess dirt or moisture from the fingers.
- Enroll and use a different finger for authentication.
- If your hands are too dry, apply lotion to them.

---

## Notice on deleting data from your hard disk drive or solid state drive

As computers spread into every corner of life, they process more and more information. The data on your computer, some of which is sensitive, is stored on a hard disk drive. Before you dispose of, sell, or hand over your computer, be sure to delete data stored on it.

Handing your computer over to someone else without deleting the loaded software, such as operating systems and application software, might even violate license agreements. You are advised to check the terms and conditions of those license agreements.

There are methods that seem to delete the data:

- Move the data to the recycle bin, and then click **Empty recycle bin**.
- Use the **Delete** option.
- Format your hard disk drive, using the software for initializing it.
- Using the recovery program provided by Lenovo to set the hard disk drive back to the factory default settings.

These operations, however, only change the file allocation of the data, they do not delete the data itself. In other words, the data retrieval processing is disabled under an operating system such as Windows. The data is still there, even though it seems to be lost. Thus, it is sometimes possible to read the data by use of special software for data recovery. There is a risk that people of bad faith might read and misuse the critical data on hard disk drives for unexpected purposes.

To prevent leakage of data, it becomes very important that you take responsibility for deleting all the data from the hard disk drive when you dispose of, sell, or hand over your computer. You can destroy the data physically by smashing the hard disk drive with a hammer, or magnetically by means of strong magnetic power, thus making the data unreadable. But we recommend that you make use of the software (payware) or service (pay service) specifically developed for the purpose.

For disposing of data on the hard disk drive, Lenovo provides the Secure Data Disposal™ tool. To download either application, go to <http://www.lenovo.com/support>.

**Note:** Running the application will take a couple of hours.

If an Encryption solid state drive or a Disk Encryption hard disk drive is supported and installed in your computer, you can logically dispose of all the data on the drive in a very short time by erasing the cryptographic key. The data encrypted with the old key is not physically erased but remains on the drive; however, it cannot be decrypted without the old key. This feature is enabled by ThinkPad Setup Menu Extension Utility and is available as a menu item in ThinkPad Setup.

---

## Using firewalls

If your system is preinstalled with a firewall program, it protects against computer Internet security threats, unauthorized access, intrusions, and Internet attacks. It also protects your privacy.

For more information about how to use the firewall program, refer to the help information system that comes with the program.

---

## Protecting data against viruses

Your computer is preinstalled with an antivirus program so you can detect and eliminate viruses. The antivirus program is designed to help you detect and eliminate viruses.

Lenovo provides a full version of antivirus software on your computer with a free 30-day subscription. After 30 days, you must renew the license to continue receiving the antivirus software updates.

For more information about how to use your antivirus software, refer to the help information system of your antivirus software.

---

## Chapter 5. Recovery overview

This chapter provides information about the recovery solutions provided by Lenovo.

- “Creating and using recovery media” on page 61
- “Performing backup and recovery operations” on page 62
- “Using the Rescue and Recovery workspace” on page 63
- “Creating and using a rescue medium” on page 64
- “Reinstalling preinstalled applications and device drivers” on page 65
- “Solving recovery problems” on page 66

### Notes:

- There are a variety of methods to choose from when considering how to recover in the event of a software- or hardware-related problem. Some methods vary depending on the type of your operating system.
- The product on the recovery media might be used only for the following purposes:
  - Restore the product preinstalled on your computer
  - Reinstall the product
  - Modify the product using the Additional Files

**Notes:** To prevent potential performance risks or unexpected behavior that might be caused by the new hard disk drive technology, it is recommended that you use one of the following back-up software programs:

- ThinkVantage Rescue and Recovery version 4.3 or later
- Symantec Norton Ghost version 15 or later

**Notes:** To use this program, do the following:

1. Click **Start** → **Run**. The Run window opens.
  2. Type `cmd` in the field. Then click **OK**.
  3. Type `ghost -align=1mb` and press Enter.
- Acronis True Image 2010 or later
  - Paragon Backup & Recovery 10 Suit or later, Paragon Backup & Recovery 10 Home or later

---

## Creating and using recovery media

You can use recovery media to restore the hard disk drive to the factory default settings. Recovery media are useful if you transfer the computer to another area, sell the computer, recycle the computer, or put the computer in an operational state after all other methods of recovery have failed. As a precautionary measure, it is important to create recovery media as early as possible.

**Note:** The recovery operations you can perform using recovery media vary depending on the operating system from which the recovery media were created. The recovery media might contain a boot medium and a data medium. Your Microsoft Windows license permits you to create only one data medium, so it is important that you store the recovery media in a safe place after you have made them.

### Creating recovery media

**Note:** On the Windows 7 operating system, you can create recovery media using discs or external USB storage devices.

To create recovery media on the Windows 7 operating system, click **Start → All Programs → Lenovo ThinkVantage Tools → Factory Recovery Disks**. Then, follow the instructions on the screen.

### Using recovery media

On the Windows 7 operating system operating system, you can use recovery media to restore the computer to the factory default settings only.

**Attention:** When you use recovery media to restore the computer to the factory default settings, all the files currently on the hard disk drive will be deleted and replaced by the factory default settings.

To use recovery media on the Windows 7 operating system operating system, do the following:

1. Depending on the type of your recovery media, connect the boot medium (memory key or other USB storage device) to the computer, or insert the boot disc into the optical drive.
2. Turn off the computer and then turn it on.
3. When ThinkPad logo is displayed, repeatedly press and release the F12 key. When the Boot Menu window opens, release the F12 key.
4. Select the desired startup device and press Enter. The restore process begins.
5. Follow the instructions on the screen to complete the operation.

### Notes:

1. After restoring your computer to the factory default settings, you might have to reinstall device drivers for some devices. See “Reinstalling preinstalled applications and device drivers” on page 65.
2. Some computers come with Microsoft Office or Microsoft Works preinstalled. If you need to recover or reinstall your Microsoft Office or Microsoft Works applications, you must use the *Microsoft Office CD* or *Microsoft Works CD*. These discs are provided only with computers preinstalled with Microsoft Office or Microsoft Works.

---

## Performing backup and recovery operations

Use the Rescue and Recovery program to back up all your hard disk drive contents including the operating system, data files, software programs, and personal settings. You can designate where the Rescue and Recovery program stores the backup:

- In a protected area of your hard disk drive
- On the secondary hard disk drive if a secondary hard disk drive is installed in your computer
- On an attached external USB hard disk drive
- On a network drive
- On recordable discs (a recordable optical drive is required for this option)

After you have backed up the contents on the hard disk drive, you can restore the complete contents of the hard disk drive, restore only the selected files, or restore only the Windows operating system and applications.

### Performing a backup operation

To perform a backup operation using the Rescue and Recovery program on the Windows 7 operating system, do the following:

1. From the Windows desktop, click **Start → All Programs → Lenovo ThinkVantage Tools → Enhanced Backup and Restore**. The Rescue and Recovery program opens.
2. In the Rescue and Recovery main window, click the **Launch advanced Rescue and Recovery** arrow.
3. Click **Back up your hard drive** and select backup operation options. Then, follow the instructions on the screen to complete the backup operation.



## Performing a recovery operation

To perform a recovery operation using the Rescue and Recovery program on the Windows 7 operating system, do the following:

1. From the Windows desktop, click **Start → All Programs → Lenovo ThinkVantage Tools → Enhanced Backup and Restore**. The Rescue and Recovery program opens.
2. In the Rescue and Recovery main window, click the **Launch advanced Rescue and Recovery** arrow.
3. Click the **Restore your system from a backup** icon.
4. Follow the instructions on the screen to complete the recovery operation.

For more information about performing a recovery operation from the Rescue and Recovery workspace, see “Using the Rescue and Recovery workspace” on page 63.

---

## Using the Rescue and Recovery workspace

The Rescue and Recovery workspace resides in a protected, hidden area of your hard disk drive that operates independently from the Windows operating system. It enables you to perform recovery operations even if you cannot start the Windows operating system. You can perform the following recovery operations from the Rescue and Recovery workspace:

- **Rescue files from your hard disk drive or from a backup**

The Rescue and Recovery workspace enables you to locate files on your hard disk drive and transfer them to a network drive or other recordable media, such as a USB device or a disc. This solution is available even if you did not back up your files or if changes were made to the files since your last backup operation. You also can rescue individual files from a Rescue and Recovery backup located on your local hard disk drive, a USB device, or a network drive.

- **Restore your hard disk drive from a Rescue and Recovery backup**

If you have backed up your hard disk drive using the Rescue and Recovery program, you can restore the hard disk drive from a Rescue and Recovery backup, even if you cannot start the Windows operating system.

- **Restore your hard disk drive to the factory default settings**

The Rescue and Recovery workspace enables you to restore the complete contents of your hard disk drive to the factory default settings. If you have multiple partitions on your hard disk drive, you have the option to restore the factory default settings to the C: partition and leave the other partitions intact. Because the Rescue and Recovery workspace operates independently from the Windows operating system, you can restore the factory default settings even if you cannot start the Windows operating system.

**Attention:** If you restore the hard disk drive from a Rescue and Recovery backup or restore the hard disk drive to the factory default settings, all files on the primary hard disk drive partition (usually drive C:) will be deleted in the recovery process. If possible, make copies of important files. If you are unable to start the Windows operating system, you can use the rescue files feature of the Rescue and Recovery workspace to copy files from your hard disk drive to other media.

To start the Rescue and Recovery workspace, do the following:

1. Turn off the computer and then turn it on.
2. When the ThinkPad logo is displayed, press the black button or repeatedly press and release the F11 key.
3. If you have set a Rescue and Recovery password, type your password when prompted. The Rescue and Recovery workspace opens after a short delay.

**Note:** If the Rescue and Recovery workspace fails to open, see “Solving recovery problems” on page 66.

4. Do one of the following:

- To rescue files from your hard disk drive or from a backup, click **Rescue files** and follow the instructions on the screen.
- To restore your hard disk drive from a Rescue and Recovery backup or to restore your hard disk drive to the factory default settings, click **Restore your system** and follow the instructions on the screen.

For more information about the features of the Rescue and Recovery workspace, click **Help**.

**Notes:**

1. After restoring your hard disk drive to the factory default settings, you might have to reinstall device drivers for some devices. See “Reinstalling preinstalled applications and device drivers” on page 65.
2. Some computers come with Microsoft Office or Microsoft Works preinstalled. If you need to recover or reinstall your Microsoft Office or Microsoft Works applications, you must use the *Microsoft Office CD* or *Microsoft Works CD*. These discs are provided only with computers preinstalled with Microsoft Office or Microsoft Works.

## Creating and using a rescue medium

With a rescue medium, such as a disc or a USB hard disk drive, you can recover the computer from failures that prevent you from gaining access to the Rescue and Recovery workspace on your hard disk drive.

**Notes:**

1. The recovery operations you can perform using a rescue medium vary depending on the operating system.
2. The rescue disc can be started in all types of optical drives.

### Creating a rescue medium

To create a rescue medium on the Windows 7 operating system, do the following:

1. From the Windows desktop, click **Start → All Programs → Lenovo ThinkVantage Tools → Enhanced Backup and Restore**. The Rescue and Recovery program opens.
2. In the Rescue and Recovery main window, click the **Launch advanced Rescue and Recovery** arrow.
3. Click the **Create Rescue Media** icon. The Create Rescue and Recovery Media window opens.
4. In the **Rescue Media** area, select the type of the rescue medium you want to create. You can create a rescue medium using a disc, a USB hard disk drive, or a secondary internal hard disk drive.
5. Click **OK** and follow the instructions on the screen to create a rescue medium.

### Using a rescue medium

This section provides instructions on how to use the rescue medium you have created.

- If you have created a rescue medium using a disc, use the following instructions to use the rescue medium:
  1. Turn off your computer.
  2. Repeatedly press and release the F12 key when turning on the computer. When the Boot Menu window is displayed, release the F12 key.
  3. In the Boot Menu window, select the desired optical drive as the first boot device. Then, insert the rescue disc into the optical drive and press Enter. The rescue medium starts.
- If you have created a rescue medium using a USB hard disk drive, use the following instructions to use the rescue medium:
  1. Attach the USB hard disk drive to one of the USB connectors on your computer.
  2. Repeatedly press and release the F12 key when turning on the computer. When the Boot Menu window opens, release the F12 key.

3. In the Boot Menu window, select the USB hard disk drive as the first boot device and press Enter. The rescue medium starts.
- If you have created a rescue medium using the secondary internal hard disk drive, set the secondary internal hard disk drive as the first boot device in the startup device sequence to start the rescue medium.

When the rescue medium starts, the Rescue and Recovery workspace opens. The help information for each feature is available from the Rescue and Recovery workspace. Follow the instructions to complete the recovery process.

---

## Reinstalling preinstalled applications and device drivers

Your computer has provisions that enable you to reinstall selected factory-installed applications and device drivers.

### Reinstalling preinstalled applications

To reinstall selected application programs, do the following:

1. Turn on your computer.
2. Go to the C:\SWT00LS directory.
3. Open the APPS folder. In it are several subfolders named for the various preinstalled applications.
4. Open the subfolder for the application you are reinstalling.
5. Double-click **Setup**, and then follow the on-screen steps to reinstall the program.

### Reinstalling preinstalled device drivers

**Attention:** When you reinstall device drivers, you are changing the current configuration of your computer. Reinstall device drivers only when it is necessary to correct a problem with your computer.

To reinstall a device driver for a factory-installed device, do the following:

1. Turn on your computer.
2. Go to the C:\SWT00LS directory.
3. Open the DRIVERS folder. Within the DRIVERS folder are several subfolders named for the various devices installed in your computer (for example, AUDIO and VIDEO).
4. Open the subfolder for the device.
5. Reinstall the device driver by one of the following methods:
  - In the subfolder for the device, look for a text file (a file with the extension .txt). The text file contains information on how to reinstall that device driver.
  - If the subfolder for the device contains a file of setup information (a file with the extension .inf), you can use the Add New Hardware program (in the Windows Control Panel) to reinstall the device driver. Not all device drivers can be reinstalled by use of this program. In the Add New Hardware program, when prompted for the device driver you want to install, click **Have Disk** and **Browse**. Then select the device driver file from the device subfolder.
  - In the subfolder for the device, look for the executable file (a file with the extension .exe). Double-click the file, and follow the instructions on the screen.

**Attention:** If you need updated device drivers, do not download them from the Windows Update Web site. Obtain them from Lenovo. For more information, see “Making sure device drivers are current” on page 126.

---

## Solving recovery problems

If you are unable to access the Rescue and Recovery workspace or the Windows environment, do one of the following:

- Use a rescue medium to start the Rescue and Recovery workspace. See “Creating and using a rescue medium” on page 64.
- Use recovery media if all other methods of recovery have failed and you need to restore the hard disk drive to the factory default settings. See “Performing backup and recovery operations” on page 62.

**Note:** If you are unable to access the Rescue and Recovery workspace or the Windows environment from a rescue medium or recovery media, you might not have the rescue device (an internal hard disk drive, a disc, a USB hard disk drive, or other external devices) set as the first boot device in the startup device sequence. You must first make sure that your rescue device is set as the first boot device in the startup device sequence in the Setup Utility program. See “Startup menu” on page 119 for detailed information about temporarily or permanently changing the startup device sequence. For more information about the Setup Utility program, see “ThinkPad Setup” on page 108.

It is important to create a rescue medium and a set of recovery media as early as possible and store them in a safe place for future use.

---

## Chapter 6. Replacing devices

This chapter provides instructions on how to install or replace some hardware for your computer.

- “Static electricity prevention” on page 67
- “Replacing the battery” on page 67
- “Replacing the SIM card” on page 70
- “Replacing the hard disk drive or solid state drive” on page 71
- “Replacing a memory module” on page 73
- “Replacing the keyboard” on page 76
- “Replacing the palm rest” on page 79
- “Replacing the speaker” on page 83
- “Replacing the backup battery” on page 84

---

### Static electricity prevention

Static electricity, although harmless to you, can seriously damage computer components and options. Improper handling of static-sensitive parts can cause damage to the part. When you unpack an option or CRU, do not open the static-protective package containing the part until the instructions direct you to install it.

When you handle options or CRUs, or perform any work inside the computer, take the following precautions to avoid static-electricity damage:

- Limit your movement. Movement can cause static electricity to build up around you.
- Always handle components carefully. Handle adapters, memory modules, and other circuit boards by the edges. Never touch exposed circuitry.
- Prevent others from touching components.
- When you install a static-sensitive option or CRU, touch the static-protective package containing the part to a metal expansion-slot cover or other unpainted metal surface on the computer for at least two seconds. This reduces static electricity from the package and your body.
- When possible, remove the static-sensitive part from the static-protective packaging and install the part without setting it down. When this is not possible, place the static-protective packaging on a smooth, level surface and place the part on it.
- Do not place the part on the computer cover or other metal surface.

---

### Replacing the battery

Before you start, print these instructions.

This system supports only batteries specially designed for this specific system and manufactured by Lenovo or an authorized builder. The system does not support unauthorized batteries or batteries designed for other systems. If an unauthorized battery or a battery designed for another system is installed, the system will not charge.

**Attention:** Lenovo has no responsibility for the performance or safety of unauthorized batteries, and provides no warranties for failures or damage arising out of their use.



**If the rechargeable battery pack is incorrectly replaced, there is danger of an explosion. The battery pack contains a small amount of harmful substances. To avoid possible injury:**

- **Replace only with a battery of the type recommended by Lenovo.**
- **Keep the battery pack away from fire.**
- **Do not expose it to excessive heat.**
- **Do not expose it to water or rain.**
- **Do not short-circuit it.**
- **Do not drop, crush, puncture, or subject to strong forces. Battery abuse or mishandling can cause the battery to overheat, which can cause gasses or flame to “vent” from the battery pack or coin cell.**

To replace the battery, do the following:

1. Turn off the computer. Then disconnect the ac power adapter and all cables from the computer.
2. Close the computer display, and turn the computer over.

3. Unlock the battery latch **1** and hold the latch **2** in the unlocked position.

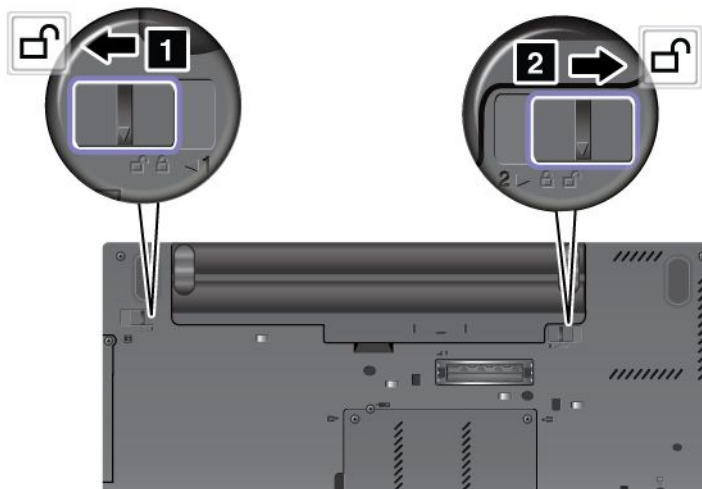

4. Remove the battery.

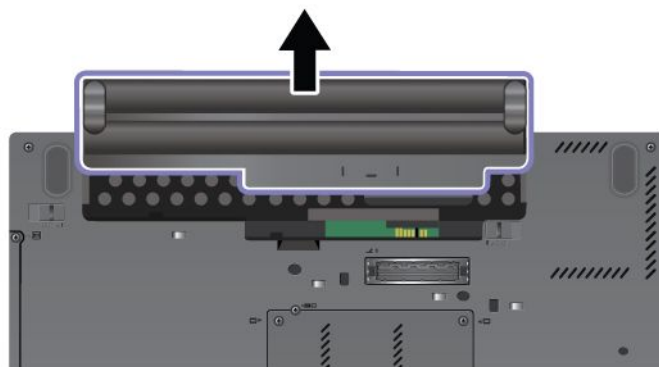

5. Slide the new battery into the computer.

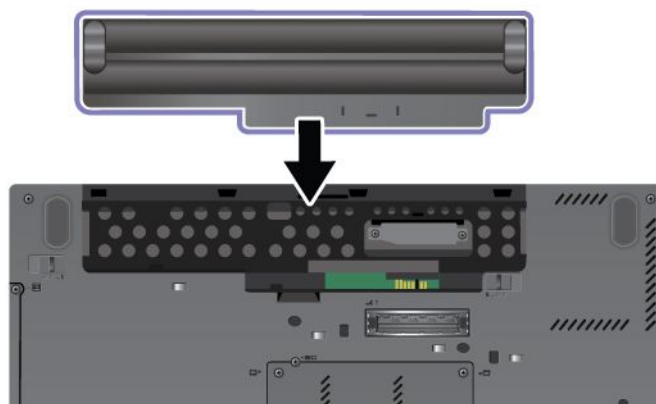

6. Make sure that the battery latch to the locked position.

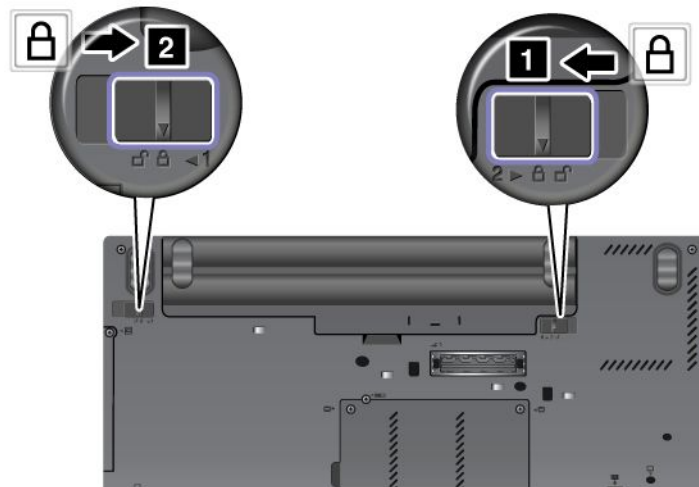

7. Turn the computer over again. Connect the ac power adapter and all cables.

---

## Replacing the SIM card

Before you start, print these instructions.

Your computer might require a SIM card to establish wireless WAN connections. Depending on the country of delivery, you might need to purchase a SIM card or a SIM card might already be installed in your computer or is part of the shipping contents that come with your computer.

If you find a SIM card included in the shipping contents, a dummy card is installed in the SIM card slot. Then proceed with the following instructions.

**Note:** The SIM card is identified by the IC chip mounted on one side of the card.

To replace the SIM card, do the following:

1. Turn off the computer; then disconnect the ac power adapter and all cables from the computer.
2. Close the computer display, and turn it over.
3. Remove the battery. See “Replacing the battery” on page 67.
4. Find the SIM card slot inside the open battery compartment. Remove the card.

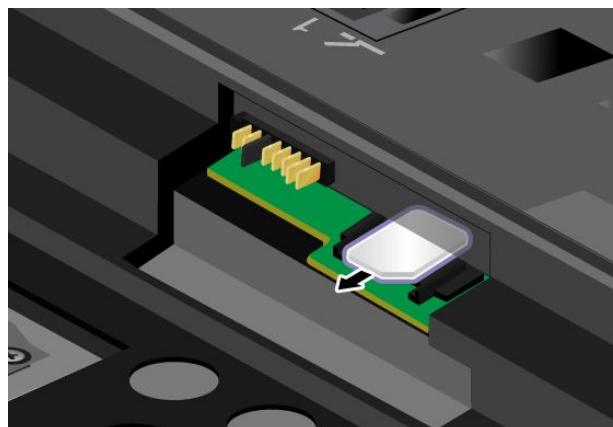



5. Insert the new SIM card firmly into the slot.

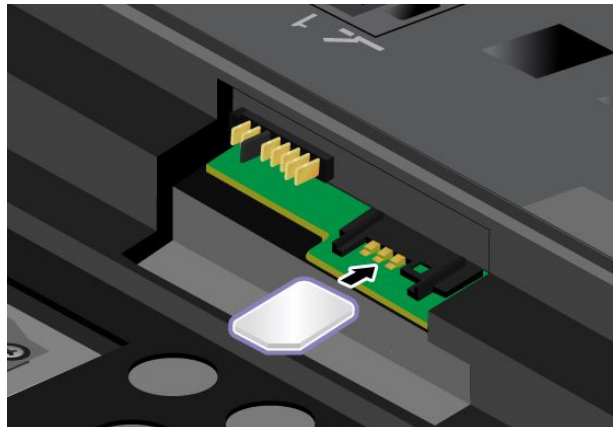

6. Reinstall the battery. See “Replacing the battery” on page 67.
7. Turn the computer over again. Connect the ac power adapter and all cables.

---

## Replacing the hard disk drive or solid state drive

Before you start, print these instructions.

When replacing the drive, be sure to follow the precautions.

**Attention:** The hard disk drive or solid state drive is very sensitive. Incorrect handling can cause damage and permanent loss of data. Observe the following guidelines:

- Replace the hard disk drive or solid state drive only if you upgrade it or have it repaired. The connectors and slot of the hard disk drive or solid state drive are not designed for frequent changes, or drive swapping.
- Do not drop the drive or subject it to physical shocks. Put the drive on a material, such as soft cloth, that absorbs any physical shocks.
- Do not apply pressure to the cover of the drive.
- Do not touch the connector.
- Before removing the hard disk drive, make a backup copy of all the information on it, and then turn the computer off.
- Never remove the drive while the computer is operating, in sleep mode, or in hibernation mode.

To replace the hard disk drive or solid state drive, do the following:

1. Turn off the computer, then disconnect the ac power adapter and all cables from the computer.
2. Close the computer display, and turn the computer over.
3. Remove the battery. See “Replacing the battery” on page 67.

4. Loosen the screw that secures the slot cover. Then remove the cover.

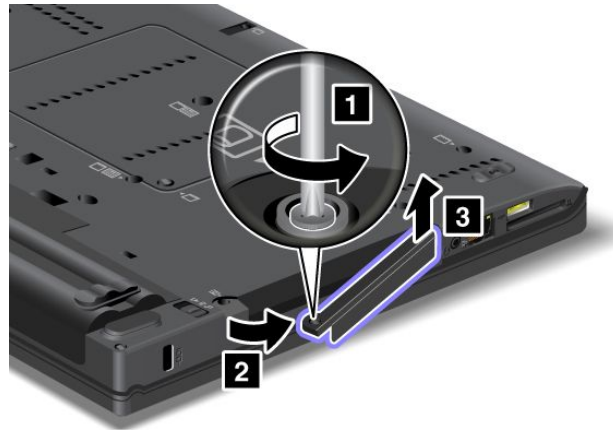

5. Remove the hard disk drive or solid state drive by pulling out the tab.



6. Detach the side rubber rails from the hard disk drive or the side spacer rails from the solid state drive.

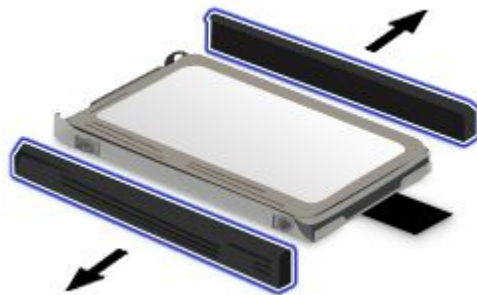

7. Attach the side rubber rails to the new hard disk drive or the new solid state drive.

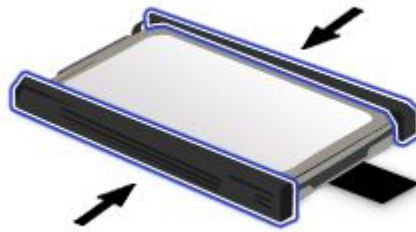

8. Insert the new hard disk drive or solid state drive into the slot.

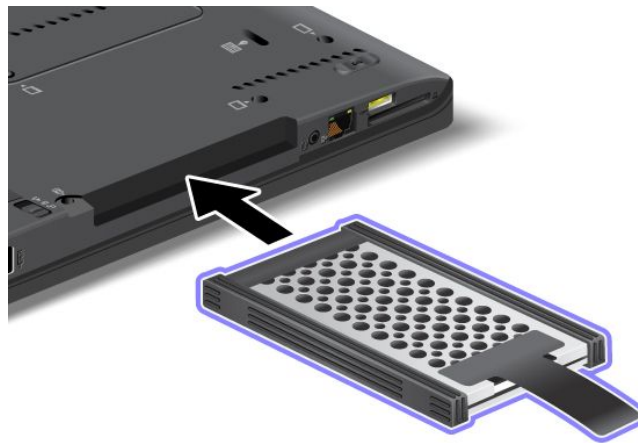

9. Reinstall the slot cover and tighten the screw to secure it.

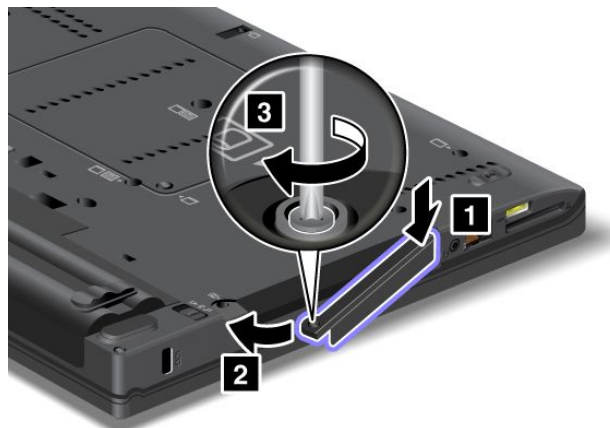

10. Reinstall the battery. See “Replacing the battery” on page 67.
11. Turn the computer over again. Connect the ac power adapter and all cables.

---

## Replacing a memory module

Before you start, print these instructions.

**Note:** The operating speed of the memory module has dependency on the system configuration. In some conditions, the memory in your computer might not be able to operate at the maximum speed.

**Attention:** Before you start installing a memory module, touch a metal table or a grounded metal object. This action reduces any static electricity from your body. The static electricity could damage the memory module.

To replace a memory module, do the following:

1. Turn off the computer; then disconnect the ac power adapter and all cables from the computer.
2. Close the computer display, and turn it over.
3. Remove the battery. See “Replacing the battery” on page 67.
4. Loosen the screws that secure the memory slot cover **1**, then remove the cover **2**.

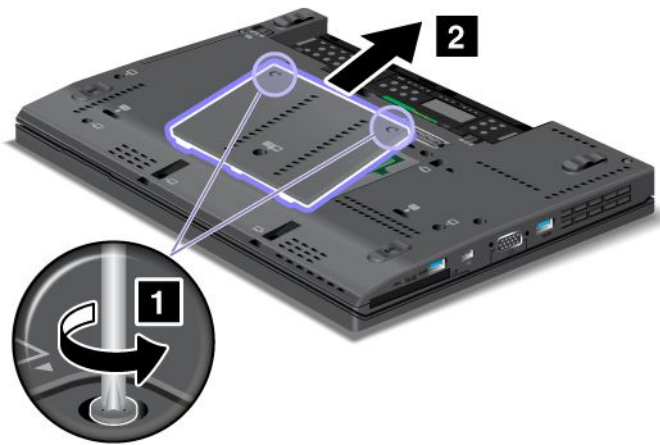

If two memory modules already are installed in the memory slots, remove a memory module to make room for the new one by pressing out on the latches on both edges of the socket at the same time **1** and removing the memory module **2**. Save the removed memory module for future use.

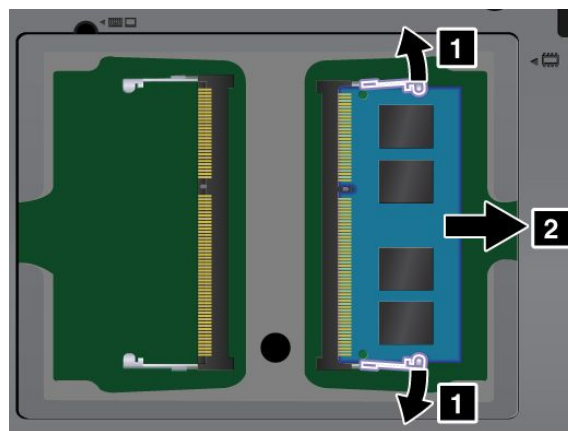

5. Find the notch on the contact edge side of the memory module you are installing.

**Attention:** To avoid damaging the memory module, do not touch its contact edge.

6. With the notched end of the memory module toward the contact edge side of the socket, insert the memory module into the socket at an angle of about 20 degrees **1**; then press it in firmly **2**.

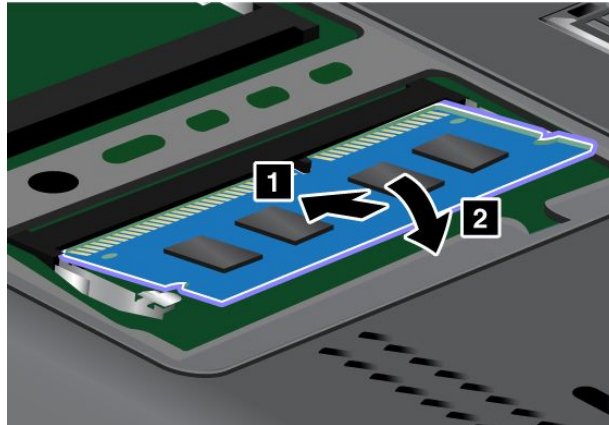

7. Pivot the memory module downward until it snaps into place.
8. Make sure that the memory module is firmly fixed in the slot and cannot be moved easily.
9. Reinstall the memory slot cover and tighten the screws to secure it.

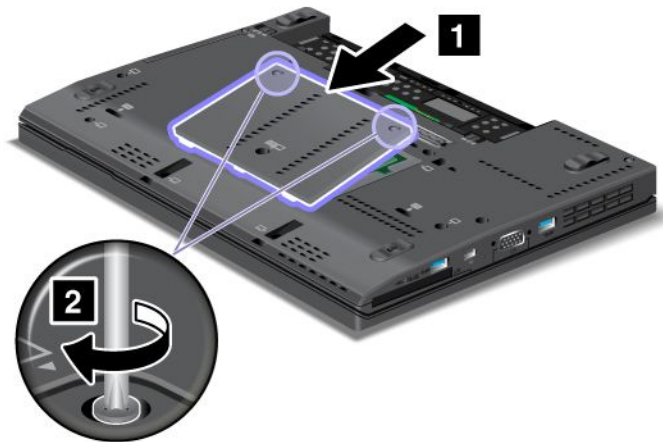

10. Reinstall the battery. See “Replacing the battery” on page 67.
11. Turn the computer over again. Connect the ac power adapter and all cables.

### Checking the total amount of memory installed in your computer

To make sure that the memory modules are installed correctly, you can check the total amount of memory your computer has by doing the following:

1. Turn the computer on.
2. When the logo screen is displayed, press F1. The ThinkPad Setup program opens. The **Installed memory** item shows the total amount of memory installed in your computer.

3. If the **Installed memory** item shows a different amount of memory from what you installed, check whether you have correctly followed the instructions in this section.

---

## Replacing the keyboard

Before you start, print these instructions.



**Electric current from power, telephone, and communication cables is hazardous. To avoid shock hazard, disconnect the cables before opening the cover of this slot.**

### Removing the keyboard

To remove the keyboard, do the following:

1. Turn off the computer; then disconnect the ac power adapter and all cables from the computer. Wait for three to five minutes, till the inside of the computer cools.
2. Close the computer display, and turn the computer over.
3. Remove the battery. See “Replacing the battery” on page 67.
4. Remove the two screws that secure the keyboard.

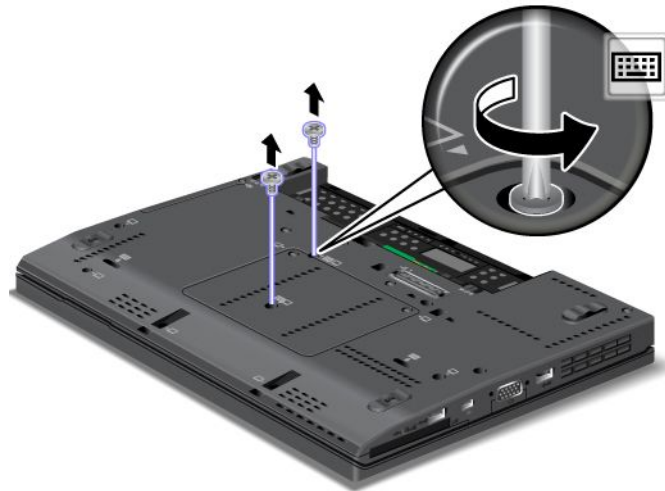

5. Turn the computer over and open the display.

6. Push hard in the direction shown by the arrows **1** to unlatch the front side of the keyboard. The keyboard will open up slightly **2**.



7. Carefully lift the keyboard until you can see how it is connected. Hold the keyboard above the computer **1**, and then detach the connector **2**. Remove the keyboard.



### Installing the keyboard

To install the keyboard, do the following:



1. Attach the connector.



2. Insert the keyboard. Make sure that the rear edges of the keyboard are under the frame.





3. Press gently on the keyboard and slide the keyboard in the direction shown by the arrows. Make sure that the edges of the keyboard are under the frame.



4. Turn the computer over and reinstall the screws.

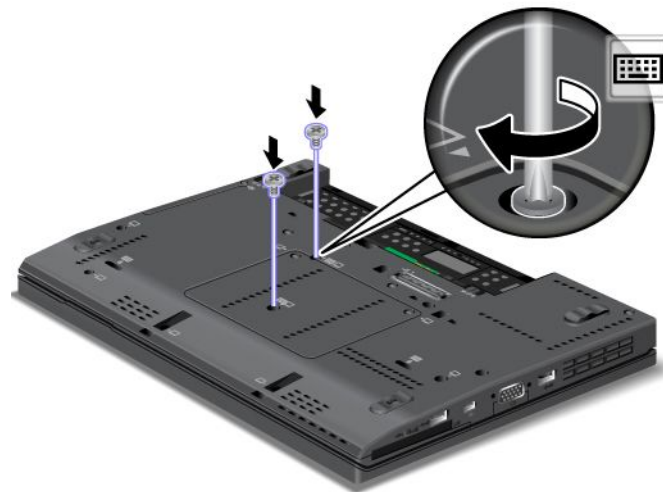

5. Reinstall the battery. See “Replacing the battery” on page 67.
6. Turn the computer over again. Connect the ac power adapter and all cables.

---

## Replacing the palm rest

Before you start, print these instructions.



**DANGER**

**Electric current from power, telephone, and communication cables is hazardous. To avoid shock hazard, disconnect the cables before opening the cover of this slot.**

## Removing the palm rest

To remove the palm rest, do the following:

1. Turn off the computer; then disconnect the ac power adapter and all cables from the computer. Wait for three to five minutes, till the inside of the computer cools.
2. Close the computer display, and turn the computer over.
3. Remove the battery. See “Replacing the battery” on page 67.
4. Remove the keyboard. See “Replacing the keyboard” on page 76.
5. Remove the screws that secure the palm rest.

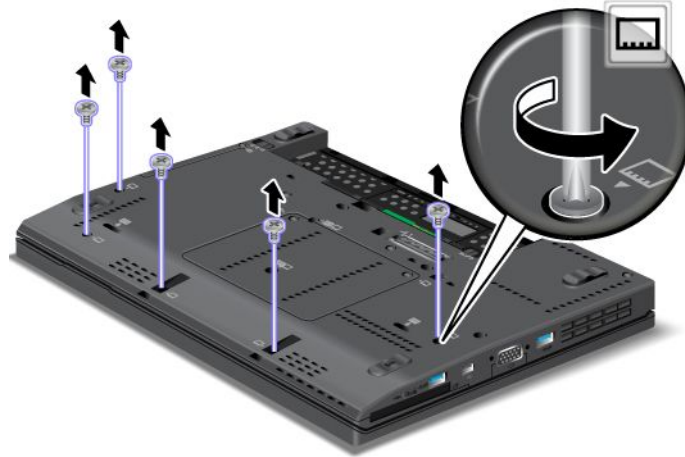

6. Turn the computer over and open the display. Detach the flip-lock ZIF connector **1**, then remove the palm rest cable **2**.



7. Lift the palm rest up and remove it.



### Installing the palm rest

To install the palm rest, do the following:

1. Attach the palm rest, making sure the latches near the top left and right edges of the palm rest are secure.



2. Press the edge of the palm rest until it clicks into place.



3. Attach the palm rest cable **1** by flipping the flip-lock ZIF connector **2** downwards.



4. Reinstall the screws to secure the palm rest.

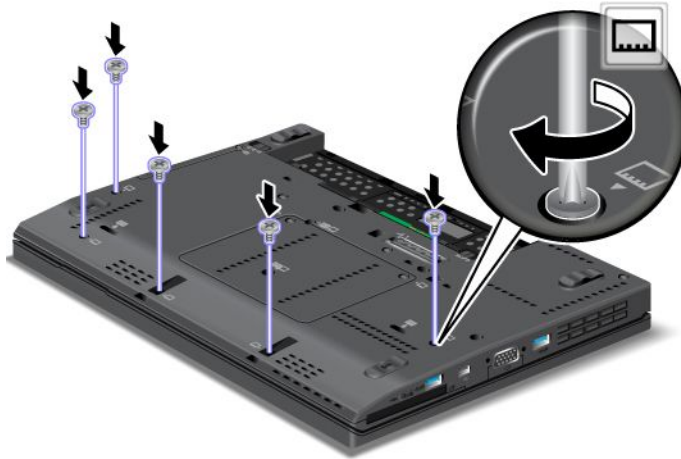

5. Reinstall the keyboard. See “Replacing the keyboard” on page 76.
6. Reinstall the battery. See “Replacing the battery” on page 67.
7. Turn the computer over again. Connect the ac power adapter and all cables.

---

## Replacing the speaker

Before you start, print these instructions.



**Electric current from power, telephone, and communication cables is hazardous. To avoid shock hazard, disconnect the cables before opening the cover of this slot.**

To replace the speaker, do the following:

1. Turn off the computer; then disconnect the ac power adapter and all cables from the computer. Wait for three to five minutes, till the inside of the computer cools.
2. Close the computer display, and turn the computer over.
3. Remove the battery. See “Replacing the battery” on page 67.
4. Remove the keyboard. See “Replacing the keyboard” on page 76.
5. Remove the palm rest. See “Replacing the palm rest” on page 79.
6. Disconnect the cable and remove the screw that secures the speaker. Then remove the speaker.

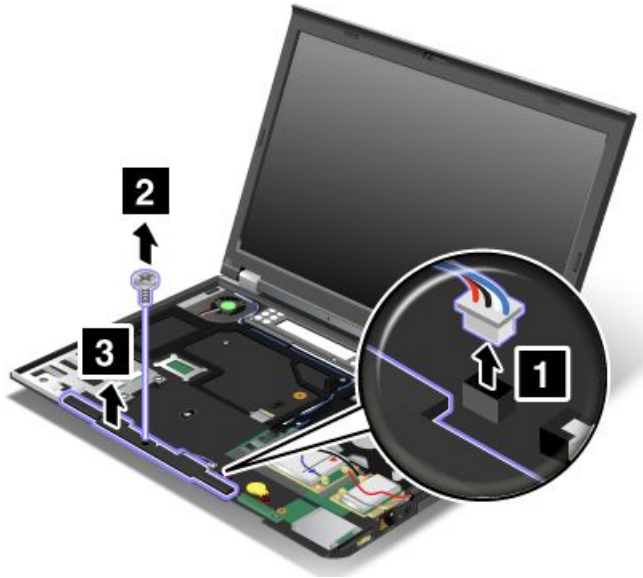

7. Put the new speaker in place and install the screw. Then connect the cable.

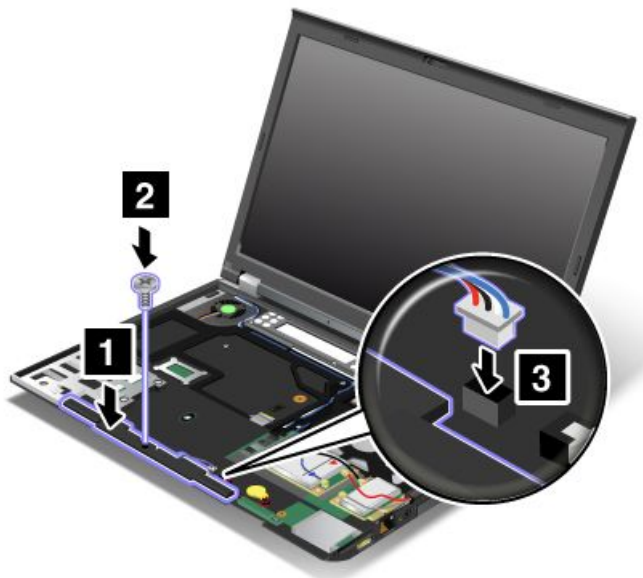

8. Reinstall the palm rest. See “Replacing the palm rest” on page 79.

9. Reinstall the keyboard. See “Replacing the keyboard” on page 76.

10. Reinstall the battery. See “Replacing the battery” on page 67.

11. Turn the computer over again. Connect the ac power adapter and all cables.

---

## Replacing the backup battery

Before you start, print these instructions.



 **DANGER**

If the backup battery is incorrectly replaced, there is danger of an explosion. The backup battery contains a small amount of harmful substances. To avoid possible injury:

- **Replace only with a battery of the type recommended by Lenovo.**
- **Keep the battery pack away from fire.**
- **Do not expose it to excessive heat.**
- **Do not expose it to water or rain.**
- **Do not short-circuit it.**
- **Do not drop, crush, puncture, or subject to strong forces. Battery abuse or mishandling can cause the battery to overheat, which can cause gasses or flame to “vent” from the battery pack or coin cell.**

To replace the backup battery, do the following:

1. Turn off the computer; then disconnect the ac power adapter and all cables from the computer. Wait for three to five minutes, till the inside of the computer cools.
2. Close the computer display, and turn the computer over.
3. Remove the battery. See “Replacing the battery” on page 67.
4. Remove the keyboard. See “Replacing the keyboard” on page 76.
5. Remove the palm rest. See “Replacing the palm rest” on page 79.
6. Disconnect the cable and remove the drained backup battery.

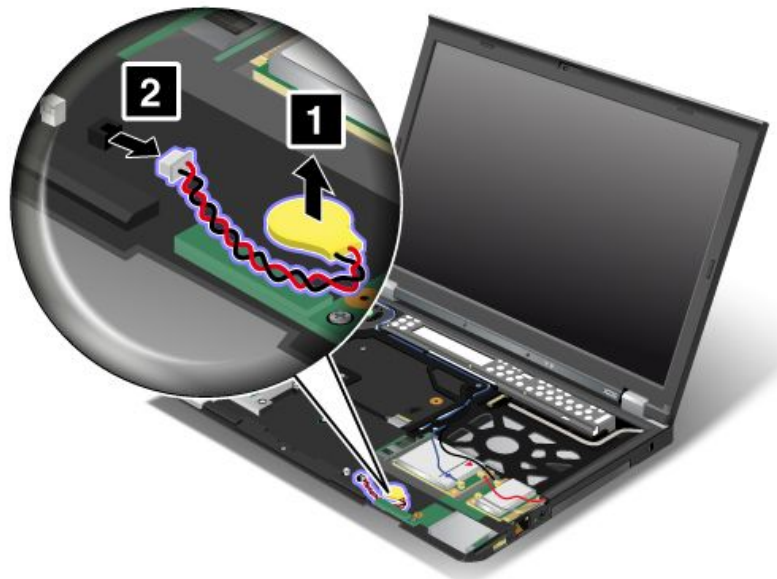

7. Put the new backup battery in place and connect the cable.

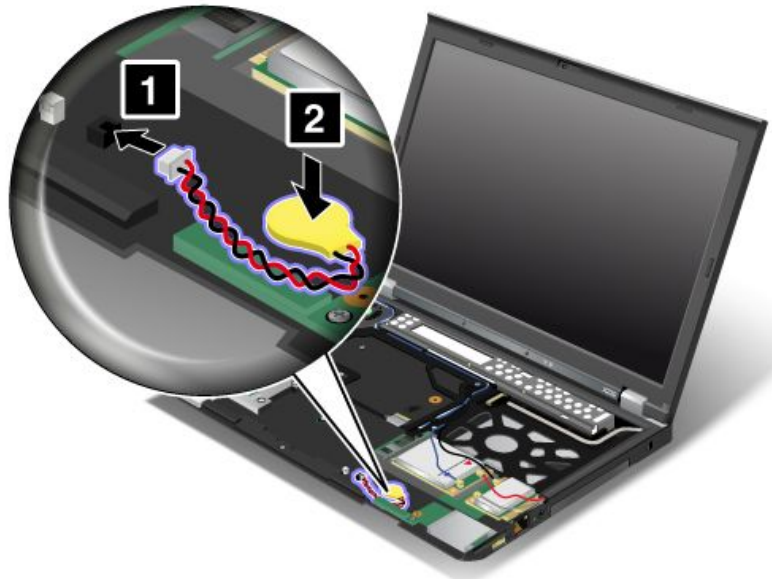

8. Reinstall the palm rest. See “Replacing the palm rest” on page 79.
9. Reinstall the keyboard. See “Replacing the keyboard” on page 76.
10. Reinstall the battery. See “Replacing the battery” on page 67.
11. Turn the computer over again. Connect the ac power adapter and all cables.



---

## Chapter 7. Enhancing your computer

This chapter provides instructions on installing hardware devices to expand your computer capabilities.

- “Finding ThinkPad options” on page 87
- “ThinkPad Battery 19+” on page 87
- “ThinkPad UltraBase Series 3” on page 90
- “Other ThinkPad port replicators and docking stations” on page 96

---

### Finding ThinkPad options

If you want to expand the capabilities of your computer, Lenovo has a number of hardware accessories and upgrades to meet your needs. Options include memory modules, storage devices, network cards, port replicators or docking stations, batteries, power adapters, printers, scanners, keyboards, mice, and more.

You can shop at Lenovo 24 hours a day, 7 days a week directly over the World Wide Web. All you need is an Internet connection and a credit card.

To shop at Lenovo, go to <http://www.lenovo.com/accessories/services/index.html>.

---

### ThinkPad Battery 19+

To extend your computer battery life, you can purchase a slim external battery pack, ThinkPad Battery 19+, from Lenovo and attach it to your computer through the docking station connector.

#### Top view



**1 Docking connector:** This is where you attach the ThinkPad computer to the ThinkPad Battery 19+.

## Bottom view

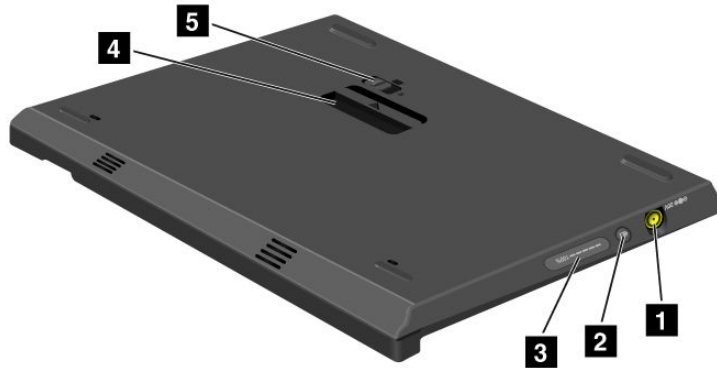

**1 Power jack:** This is where you connect the ac power adapter.

**2 Indicator button:** When you press this button, the status indicator shows the ThinkPad Battery 19+ charge status.

**3 Status indicator:** It shows the ThinkPad Battery 19+ charge status.

**4 Eject lever:** When the eject lever is released, you can detach the ThinkPad Battery 19+ from the computer.

**5 Battery latch:** When the battery latch is locked, the eject lever cannot be released.

## Attaching the ThinkPad Battery 19+

**Attention:** Before you attach the ThinkPad Battery 19+, disconnect the ac power adapter from your computer. The ac power connector will be damaged if it remains connected to the computer during the attachment.

To attach the ThinkPad Battery 19+, do the following:

1. Align the front of the computer with the front of the ThinkPad Battery 19+.



2. Ensure that the guides of the ThinkPad Battery 19+ align with the holes in the computer **1**. Then secure the computer in place **2**.



### Detaching the ThinkPad Battery 19+

To detach the ThinkPad Battery 19+, do the following:

1. Unlock the battery latch by sliding it to the unlocked position.



2. Release the eject lever 2 and detach the ThinkPad Battery 19+.



### Charging the ThinkPad Battery 19+

The ThinkPad Battery 19+ can be charged separately when connected to ac power source.

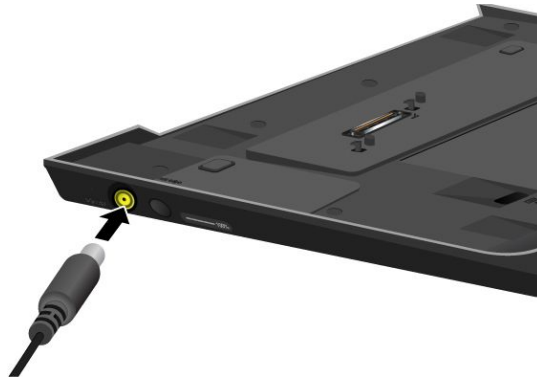

The ThinkPad Battery 19+ also can be charged with a computer attached. In this way, both the main battery and the ThinkPad Battery 19+ will be charged.



---

### **ThinkPad UltraBase Series 3**

Your computer supports the ThinkPad UltraBase Series 3, which is a docking solution provided by Lenovo to expand the working capabilities of your computer.

After you attach your computer to the ThinkPad UltraBase Series 3, you can use its connectors in place of the connectors on the computer.

When the computer is attached to the ThinkPad UltraBase Series 3, never pick up the assembly by taking hold of the computer alone. Always hold the whole assembly.

## Top view

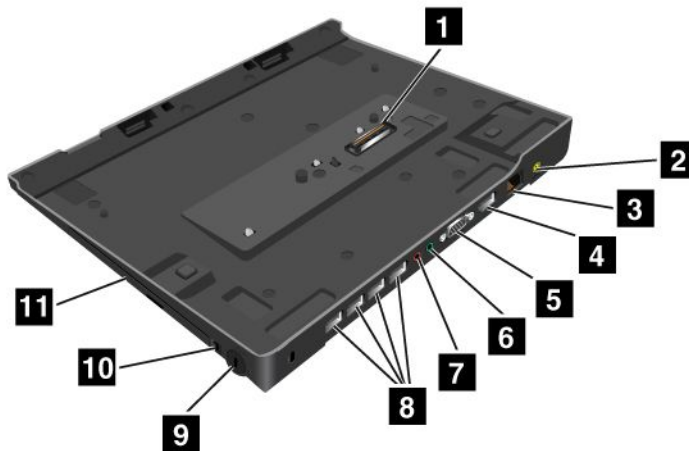

**1 Docking station connector:** This is where you attach your computer.

**2 Power jack:** Connect the ac power adapter.

**3 Ethernet connector:** Connect the ThinkPad UltraBase Series 3 to an Ethernet LAN.

**4 DisplayPort connector:** Connect a display device.

**5 Monitor connector:** Connect an external monitor or projector.

**6 Headphone jack:** 1/8 inch (3.5 mm) in diameter. Use it to connect an external headphone.

**7 Microphone jack:** 1/8 inch (3.5 mm) in diameter. Use it to connect an external microphone.

**8 USB 2.0 connectors:** Connect USB 2.0 compatible devices.

**9 Security keyhole:** Use a security cable lock that fits this keyhole to lock your ThinkPad UltraBase Series 3 to a stationary object to protect it from theft.

**10 System lock key:** Use the system lock key to lock the eject button. When the eject button is locked, you cannot attach or remove your computer.

**11 Drive bay:** Install an optical drive (DVD-ROM drive) or a second hard disk drive .

## Bottom view

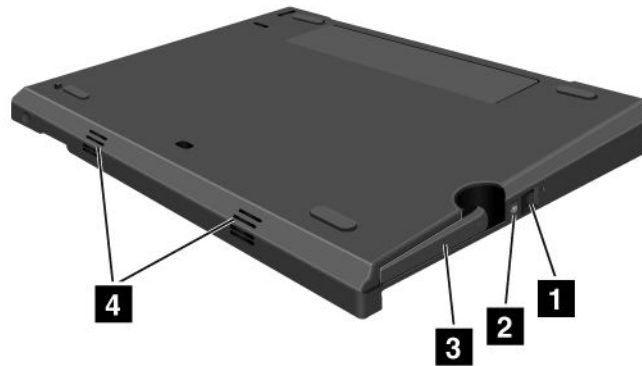

**1 Eject request button:** Press the eject request button to undock the computer.

**2 Docking status indicator:** This indicator lights red when your computer is docked. It blinks when the eject request button is pressed.

**3 Eject lever:** Use it to lift your computer up from the ThinkPad UltraBase Series 3 when you undock the computer.

**4 Speakers**

## Attaching the ThinkPad UltraBase Series 3

**Attention:** Before you attach the ThinkPad UltraBase Series 3, disconnect the ac power adapter from your computer. The ac power connector will be damaged if it remains connected to the computer during the attachment.

You can hot attach or warm attach the computer to the ThinkPad UltraBase Series 3. Hot attachment is attaching the computer to the ThinkPad UltraBase Series 3 while the computer is in operating mode; warm attachment is attaching the computer to the ThinkPad UltraBase Series 3 while the computer is in sleep mode.

In doing a hot or warm attachment, note the following:

- For hot attachment: The docking status indicator should turn on after a few seconds.
- For warm attachment: When the computer resumes from sleep mode, the docking status indicator should turn on.

To attach your computer to a ThinkPad UltraBase Series 3, do the following:

1. Ensure that the system lock key of the ThinkPad UltraBase Series 3 is in the unlocked (vertical) position.

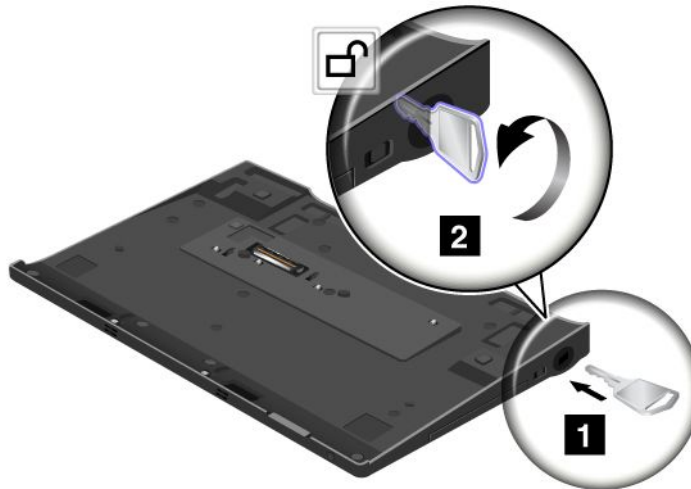

2. Align the front of the computer with the front of the ThinkPad UltraBase Series 3.



3. Ensure that the guides of the ThinkPad UltraBase Series 3 align with the holes in the computer **1**. Then secure the computer in place **2**. The docking status indicator lights.



4. Turn the system lock key to the locked position (horizontal). The computer is docked to the ThinkPad UltraBase Series 3.



**Note:** You can turn the key clockwise to lock it. Then, keep the key in a safe place. Do not lose this key; otherwise, you will be unable to detach the computer from the ThinkPad UltraBase Series 3.

## Detaching the ThinkPad UltraBase Series 3

**Attention:** Do not detach your computer from the ThinkPad UltraBase Series 3 while the docking status indicator is blinking or on. Wait until the indicator turns off. Detaching while the indicator is blinking or on causes the system to beep, and the computer might halt.

You can hot detach or warm detach the computer from the ThinkPad UltraBase Series 3. Hot detachment is detaching the computer from the ThinkPad UltraBase Series 3 while the computer is in operating mode; warm detachment is detaching the computer from the ThinkPad UltraBase Series 3 while the computer is in sleep mode.

Before performing a hot or warm detachment operation, ensure that:

- The devices connected to USB, serial, and parallel connectors are not in use.
- The connection to the Ethernet port has ended.
- The battery is fully charged.

### Performing a hot detachment operation

To perform a hot detachment operation, do the following:

1. Click **Start**, and then press the right arrow key and select **Undock**.
2. When the docking status indicator is off, detach the computer following instructions in “Detaching the computer” on page 95.

**Note:** Detaching while the computer is operating without performing the procedure above might cause the system to malfunction or hang.

### Performing a warm detachment operation

To perform a warm detachment operation, do the following:

1. Press the eject request button on the ThinkPad UltraBase Series 3. The system will then resume with an OK message.
2. When the docking status indicator is off, detach the computer following instructions in “Detaching the computer” on page 95.



## Detaching the computer

To detach your computer from the ThinkPad UltraBase Series 3, do the following:

1. Ensure that the system lock key of the ThinkPad UltraBase Series 3 is in the unlocked (vertical) position.



2. Close the computer display.
3. If you are hot-detaching or warm-detaching the computer, press the eject request button on the ThinkPad UltraBase Series 3. Then ensure that the docking status indicator is off.
4. Release the eject lever on the left side of the ThinkPad UltraBase Series 3 **1** until the computer lifts up; then remove the computer **2**.

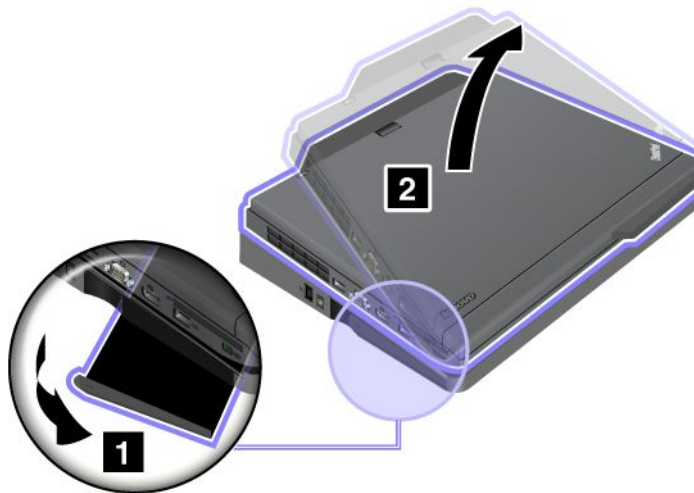

## Security feature

The lock of the ThinkPad UltraBase Series 3 has two positions.

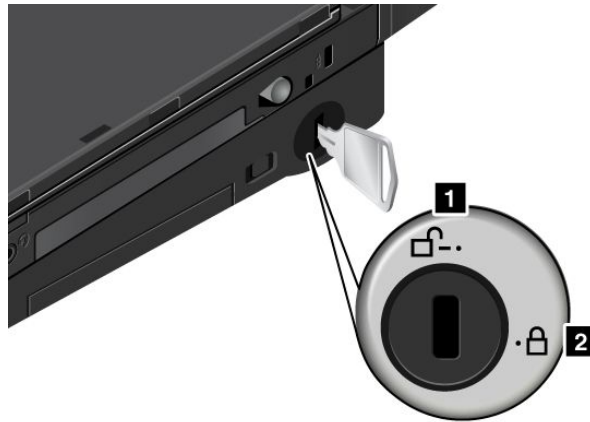

### **1** Unlocked position

When the lock is in this position, your computer is not secured.

### **2** Locked position

When the lock is in this position, the ThinkPad UltraBase Series 3 is locked, and the computer cannot be removed from the ThinkPad UltraBase Series 3. The device in the drive bay also is locked and cannot be removed.

**Note:** Keep the security key in a safe place. Do not lose this key; otherwise, you will be unable to detach the computer from the ThinkPad UltraBase Series 3.

If you have purchased a mechanical lock, you can attach the mechanical lock to the security keyhole of the ThinkPad UltraBase Series 3 to protect it from theft.

**Note:** You are responsible for evaluating, selecting, and implementing the locking device and security feature. Lenovo makes no comments, judgments, or warranties about the function, quality, or performance of the locking device and security feature.

---

## Other ThinkPad port replicators and docking stations

Depending on the model, your computer also might support the following port replicators or docking stations:

- ThinkPad Port Replicator Series 3
- ThinkPad Port Replicator Series 3 with USB 3.0
- ThinkPad Mini Dock Series 3
- ThinkPad Mini Dock Series 3 with USB 3.0
- ThinkPad Mini Dock Plus Series 3
- ThinkPad Mini Dock Plus Series 3 with USB 3.0

Attach your computer to one of the port replicators or docking stations to expand the working capability.

When the computer is attached to a port replicator or docking station, never pick up the assembly by taking hold of the computer alone. Always hold the whole assembly.

## Front view

### ThinkPad Port Replicator Series 3 and ThinkPad Port Replicator Series 3 with USB 3.0

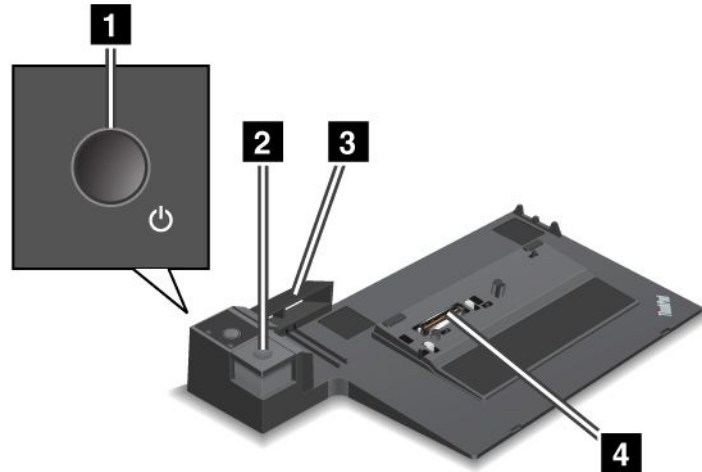

**1 Power button:** Press the power button to turn the computer on or off.

**2 Eject button:** Press the eject button to release the computer from the port replicator.

**3 Sliding adjuster:** Use the sliding adjuster as a guide to align the docking station connector on your computer as you attach the port replicator.

**4 Docking station connector:** This is where you attach your computer.

### ThinkPad Mini Dock Series 3 and ThinkPad Mini Dock Series 3 with USB 3.0

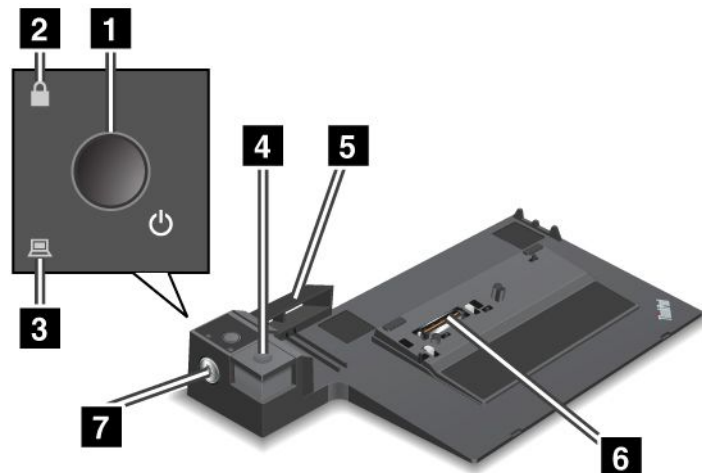

**1 Power button:** Press the power button to turn the computer on or off.

**2 Key lock indicator:** This indicator lights when the system lock key is in the locked position. When the system lock key is in the locked position, the eject button of the docking station is locked; you cannot attach or remove your computer.

**3 Docking status indicator:** This indicator lights when your computer is docked.

- 4 Eject button:** Press the eject button to release the computer from the docking station.
- 5 Sliding adjuster:** Use the sliding adjuster as a guide to align the docking station connector on your computer as you attach the docking station.
- 6 Docking station connector:** This is where you attach your computer.
- 7 System lock key:** Use the system lock key to lock the eject button. When the eject button is locked, you cannot attach or remove your computer.

**ThinkPad Mini Dock Plus Series 3 and ThinkPad Mini Dock Plus Series 3 with USB 3.0**

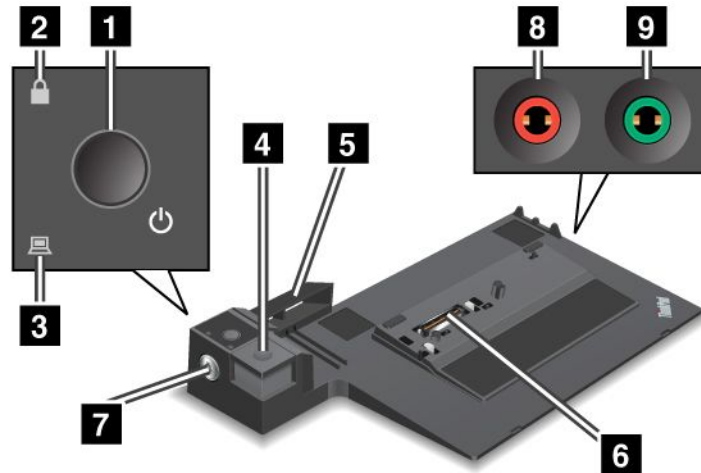

- 1 Power button:** Press the power button to turn the computer on or off.
- 2 Key lock indicator:** This indicator lights when the system lock key is in the locked position. When the system lock key is in the locked position, the eject button of the docking station is locked; you cannot attach or remove your computer.
- 3 Docking status indicator:** This indicator lights when your computer is docked.
- 4 Eject button:** Press the eject button to release the computer from the docking station.
- 5 Sliding adjuster:** Use the sliding adjuster as a guide to align the docking station connector on your computer as you attach the docking station.
- 6 Docking station connector:** This is where you attach your computer.
- 7 System lock key:** Use the system lock key to lock the eject button. When the eject button is locked, you cannot attach or remove your computer.
- 8 Microphone jack:** 1/8 inch (3.5 mm) in diameter. Use it to connect an external microphone.
- 9 Headphone jack:** 1/8 inch (3.5 mm) in diameter. Use it to connect an external headphone.

## Rear view

### ThinkPad Port Replicator Series 3 and ThinkPad Port Replicator Series 3 with USB 3.0

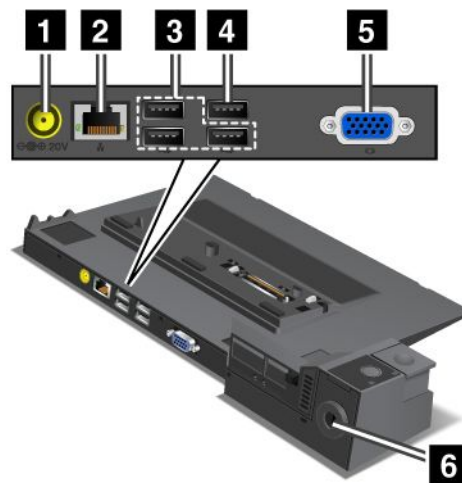

**1 Power jack:** Connect the ac power adapter.

**2 Ethernet connector:** Connect the port replicator to an Ethernet LAN. The indicator on the connector is the same as that on the computer.

**3 USB 2.0 connectors:** Connect USB 2.0 compatible devices.

**4 USB 2.0 connector** (on the ThinkPad Port Replicator Series 3) or **USB 3.0 connector** (on the ThinkPad Port Replicator Series 3 with USB 3.0): Connect compatible USB devices.

**5 External monitor connector:** Connect an external monitor.

**6 Security keyhole:** Use a security cable lock that fits this keyhole to lock your port replicator to a stationary object to protect it from theft.

### ThinkPad Mini Dock Series 3 and ThinkPad Mini Dock Series 3 with USB 3.0

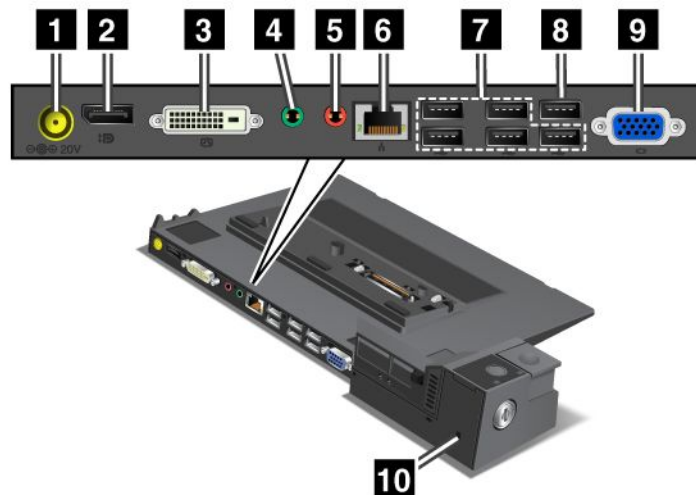

**1 Power jack:** Connect the ac power adapter.

**2 DisplayPort connector:** Connect a display device.

**3 DVI connector:** Connect a monitor that supports Single-Link DVI.

**Note:** The DVI connector provides a digital interface only. This connector can only be used with a computer that supports DVI connection established through docking stations.

**4 Headphone jack:** 1/8 inch (3.5 mm) in diameter. Use it to connect an external headphone.

**5 Microphone jack:** 1/8 inch (3.5 mm) in diameter. Use it to connect an external microphone.

**6 Ethernet connector:** Connect the port replicator to an Ethernet LAN. The indicator on the connector is the same as that on the computer.

**7 USB 2.0 connectors:** Connect USB 2.0 compatible devices.

**8 USB 2.0 connector** (on the ThinkPad Mini Dock Series 3) or **USB 3.0 connector** (on the ThinkPad Mini Dock Series 3 with USB 3.0): Connect compatible USB devices.

**9 External monitor connector:** Connect an external monitor.

**10 Security keyhole:** Use a security cable lock that fits this keyhole to lock your docking station to a stationary object to protect it from theft.

#### ThinkPad Mini Dock Plus Series 3 and ThinkPad Mini Dock Plus Series 3 with USB 3.0

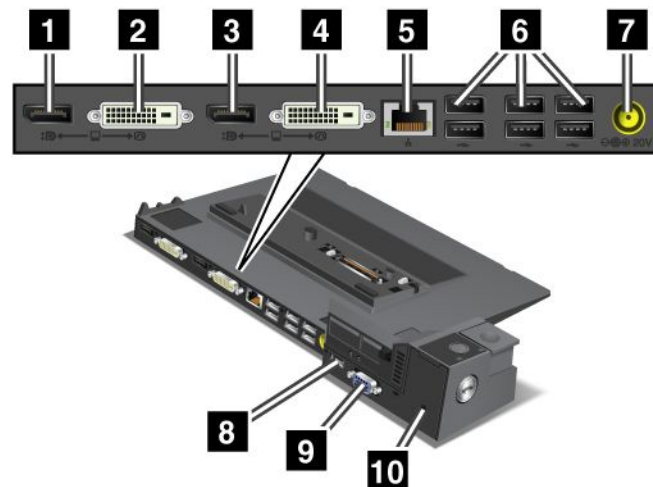

**1 3 DisplayPort connector:** Connect a display device.

**2 4 DVI connector:** Connect a monitor that supports Single-Link DVI.

**Note:** The DVI connector provides a digital interface only. This connector can only be used with a computer that supports DVI connection established through docking stations.

**5 Ethernet connector:** Connect the port replicator to an Ethernet LAN. The indicator on the connector is the same as that on the computer.

**6 USB 2.0 connectors:** Connect USB 2.0 compatible devices.

**7 Power jack:** Connect the ac power adapter.

**8 eSATA connector or USB 3.0 connector:** For the ThinkPad Mini Dock Plus Series 3, this is an eSATA connector for connecting an eSATA device. For the ThinkPad Mini Dock Plus Series 3 with USB 3.0, this is a USB 3.0 connector for connecting a USB compatible devices.

**9 External monitor connector:** Connect an external monitor.

**10 Security keyhole:** Use a security cable lock that fits this keyhole to lock your docking station to a stationary object to protect it from theft.

**Note:** If you attach your computer to a port replicator or docking station and use an Ethernet connector or an external monitor connector, use the Ethernet connector or the external monitor connector on the port replicator or docking station, not the one on the computer.

## Attaching a ThinkPad port replicator or docking station

To attach your computer to a supported ThinkPad port replicator or docking station, do the following:

### Notes:

- Before you attach the computer to a supported ThinkPad port replicator or docking station, disconnect the ac power adapter from the computer.
- If your computer is operating, make sure that it has finished any operations involving devices that are connected to a USB connector. Also make sure that any connection to an Ethernet connector has been disconnected.
- The following illustrations are for the ThinkPad Mini Dock Series 3. The procedure is the same for other docking stations. For port replicators, start with step 2.

1. Make sure that the system lock key is in place and in the unlocked (horizontal) position.

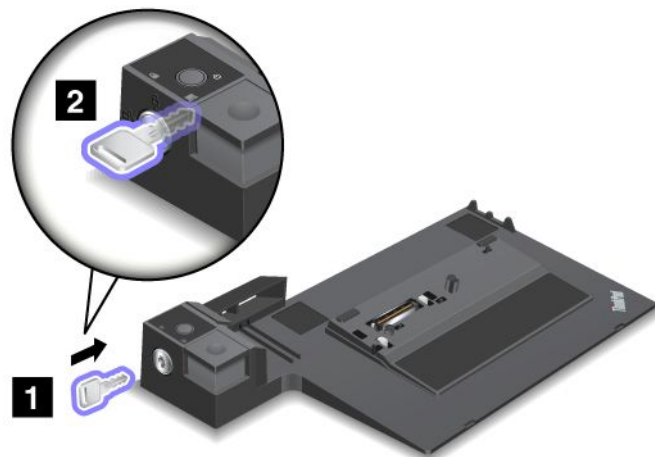

2. Press and pull the sliding adjuster as shown.

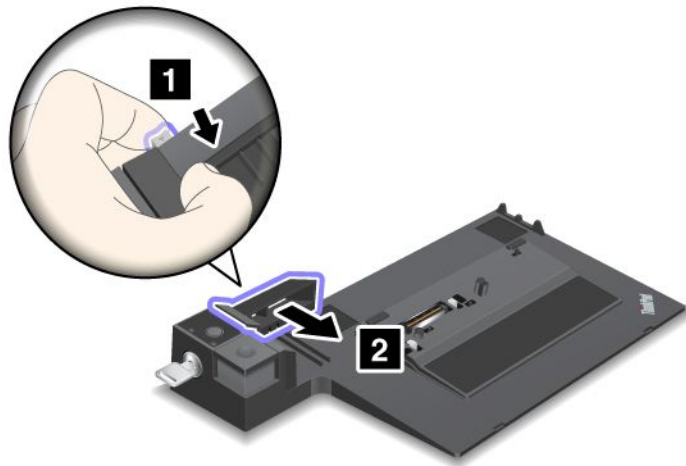

3. Put your computer on the platform of the docking station, making sure that the top-left corner of the computer is aligned to the guide plate.

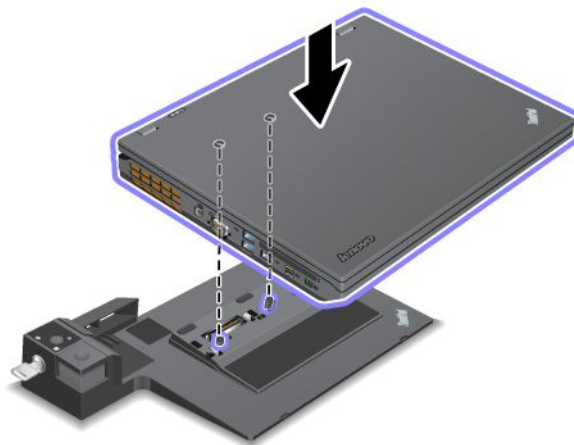

4. Insert your computer into the docking station until you hear a click. The computer is attached to the docking station.

**Note:** If the docking status indicator is not lighted after you attach the docking station, your computer is not correctly connected. Check the ac power adapter of the docking station, or disconnect and re-attach the ac power adapter. Then attach your computer to the docking station.

**Notes:**

- If you attach the port replicator or docking station to your computer, but do not connect the ac power adapter of that attachment to the power jack, your computer goes into battery mode.
- If your computer and the port replicator or docking station are connected to separate ac power adapters, your computer goes into battery mode first, and then shifts into ac power mode.
- If in either of the above two preceding situations the battery of your computer is detached, or has no battery charge, your computer shuts down.



## Connecting an external display to the ThinkPad Mini Dock Plus Series 3 and the ThinkPad Mini Dock Plus Series 3 with USB 3.0

Group 1 (top figure) and Group 2 (lower figure) are independent of each other. Each has a DisplayPort connector and a DVI connector. If you connect a display to a DisplayPort connector and a DVI connector that are in the same group, the DisplayPort connector is inactive.

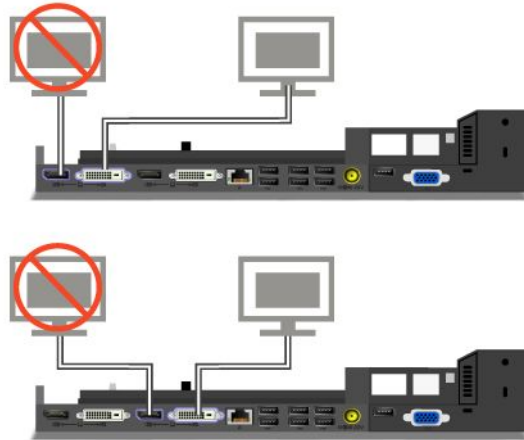

## Detaching a ThinkPad port replicator or docking station

To detach your computer from a ThinkPad port replicator, do the following:

1. Ensure that:
  - The devices connected to USB connectors are not in use.
  - The connection to an Ethernet connector has been ended.
  - The system lock key of the docking station is in place and in the unlocked (horizontal) position for:
    - ThinkPad Mini Dock Series 3
    - ThinkPad Mini Dock Series 3 with USB 3.0
    - ThinkPad Mini Dock Plus Series 3
    - ThinkPad Mini Dock Plus Series 3 with USB 3.0

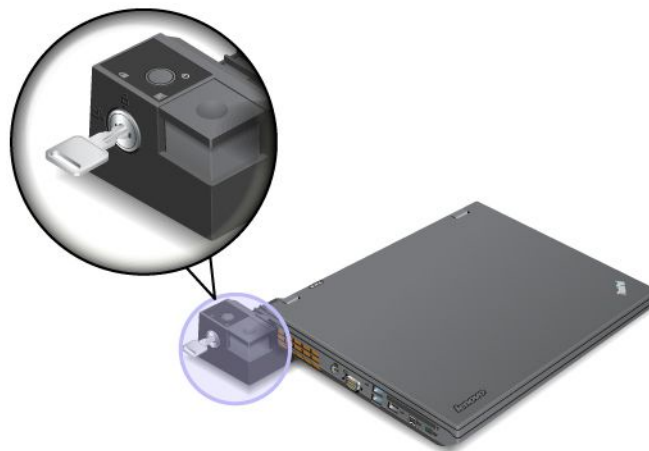

2. Press the eject button until the computer moves up. Then, grasp both sides, and remove the computer.

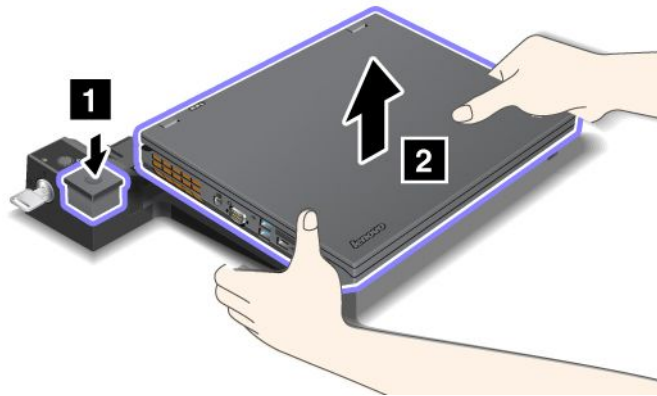

## Security feature

Use the security keyhole on the ThinkPad port replicator or docking station to attach a mechanical lock. By attaching a mechanical lock, you can secure the port replicator or docking station to a stationary object, such as a desk, to protect your port replicator or docking station from theft. Mechanical locks in different sizes are available from Lenovo as options.

**Note:** You are responsible for evaluating, selecting, and implementing the locking device and security feature. Lenovo makes no comments, judgments, or warranties about the function, quality, or performance of the locking device or security feature.

For the ThinkPad docking stations, in addition to attaching a mechanical lock to the docking station, you also can use the system lock key to lock the eject button. When the eject button is locked, the computer cannot be detached from the docking station. For more information, see “Using the system lock key” on page 104.

## Using the system lock key

The system lock key has two positions, unlocked and locked.

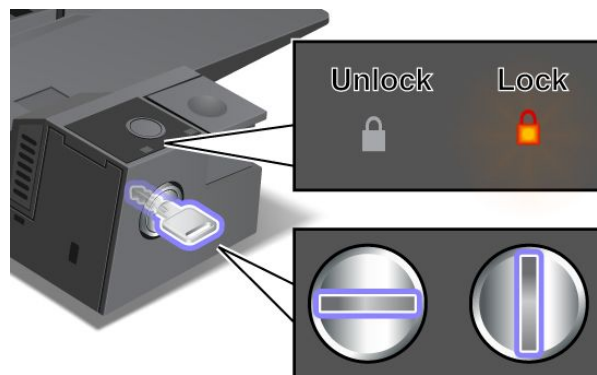

When the key is in the locked position, the eject button of the docking station is locked, and you cannot remove your computer. The key lock indicator lights when the eject button is locked.

---

## Chapter 8. Advanced configuration

While it is important to protect files, data, and settings that are on the hard disk drive, you also might need to install a new operating system, install new device drivers, update your system UEFI BIOS, or recover preinstalled software. This topic will help you handle your computer with proper care and keep it in top working shape..

- “Installing a new operating system” on page 105
- “Installing device drivers” on page 107
- “ThinkPad Setup” on page 108
- “Using system management” on page 121

---

### Installing a new operating system

If you install a new operating system in your computer, you need to install the supplement files and ThinkPad device drivers for it at the same time. The necessary files are located in the following directories of your solid state drive or hard disk drive:

- The supplement files for the operating system supported are in the C:\SWT00LS\OSFIXES directory.
- The device drivers for the operating system supported are in the C:\SWT00LS\DRIVERS directory.
- The preloaded software applications are in the C:\SWT00LS\APPS directory.

#### Notes:

- The process of installing the new operating system deletes all the data on your hard disk drive, including backups or images that were stored in a hidden folder by use of the Rescue and Recovery program.
- If you cannot find the supplement files, the device drivers, and application software you need on your hard disk drive, or if you want to receive updates and the latest information about them, go to: <http://www.lenovo.com/ThinkPadDrivers>

### Before you begin

**Note:** If your computer is equipped with both a hard disk drive and an mSATA solid state drive, you are not recommended to use the mSATA solid state drive as a bootable device. The mSATA solid state drive is designed and developed for the “cache” function purpose only. If you use the mSATA solid state drive as a bootable device, its reliability is not guaranteed.

Before you install the operating system, do the following:

- Copy all the subdirectories and files in the C:\SWT00LS directory to a removable storage device, to avoid losing files during the installation.
- Print the instructions you will use.

#### Notes:

- The UEFI BIOS features are supported only on the 64-bit version of the Windows 7 operating system.
- If you want to start Windows Recovery Environment (WinRE) in Windows 7 using the 64-bit version of the Microsoft Windows Installation DVD, you should not change the initial **UEFI/Legacy Boot** setting in ThinkPad Setup. The **UEFI/Legacy Boot** setting must be the same as it was when the Windows operating system image was installed. Otherwise, you will see an error.

For the country or region code required in the installation, use one of the following:

**Country or region: Code**

China: SC  
Denmark: DK  
Finland: FI  
France: FR  
Germany: GR  
Italy: IT  
Japan: JP  
Netherlands: NL  
Norway: NO  
Spain: SP  
Sweden: SV  
Taiwan and Hong Kong: TC  
United States: US

## Installing the Windows 7 operating system

Before you start, print these instructions.

To install the Windows 7 operating system and its related software on your computer, do the following:

1. Start ThinkPad Setup.
2. Select **Startup**.
3. Select **UEFI/Legacy Boot**.
4. Do one of the following:
  - If you want to install the Windows 7 (32-bit) operating system, select **Legacy Only** or **Both**.
  - If you want to install the Windows 7 (64-bit) operating system in Legacy mode, select **Legacy Only**.
  - If you want to install the Windows 7 (64-bit) operating system in UEFI mode, select **UEFI Only**.
5. Press F10.
6. Insert the Windows 7 operating system installation DVD into the DVD drive, and restart the computer.
7. Restore C:\SWTOOLS from the backup copy you made before starting the installation.
8. Install the Intel Chipset Support for Windows 2000/XP/Vista/7. To do this, run SETUP.exe in C:\SWTOOLS\DRIVERS\INTELINF\infinst\_autol.
9. Install device drivers. See “Installing device drivers” on page 107.

### Installing the registry patches for Windows 7

Go to <http://www.lenovo.com/support> and install the following registry patches:

- Registry patch enabling Wake Up on LAN from Standby for Energy Star
- Fix for Issue of HDD with HD Detection

### Installing the Windows 7 update module package

The Windows 7 update modules are in the following directory:

C:\SWTOOLS\OSFIXES\

The name of each subfolder is the number of a fix module. For information about each fix module, go to the Microsoft Knowledge Base homepage at <http://support.microsoft.com/>, type the number of the fix module you need in the search field, and click **Search**.

**Note:** The Web site address might change without notice. If the homepage is not displayed, search for it from the Microsoft top page.

To install a fix module, run the EXE file in a subfolder and follow the instructions on the screen.

**Note:** If you remove the hard disk drive from the computer with a single-core processor and install it on a computer with a dual-core processor, you can get access to the hard disk drive. The opposite, however, is not true: If you remove the hard disk drive from a computer with a dual-core processor and install it on a computer with a single-core processor, you cannot get access to the hard disk drive.

---

## Installing device drivers

Install necessary device drivers to use the corresponding hardware features.

### Installing the driver for the 4-in-1 media card reader

To use the 4-in-1 media card reader, you need to download and install the Ricoh Multi Card Reader Driver from the Lenovo Support Web site at:  
<http://www.lenovo.com/support>

### Installing the driver for USB 3.0 in Windows 7

If your computer is installed with the Windows 7 operating system, it supports USB 3.0 functions. To use the USB 3.0 connectors, you need to download and install the USB 3.0 driver after you reinstalled the Windows 7 operating system by doing the following:

1. Go to <http://www.lenovo.com/support>. Find your model and display the driver links.
2. Select the USB 3.0 driver for the 32-bit or 64-bit operating system and extract it to your local hard disk drive.
3. Double-click the Setup.exe file in the C:\DRIVERS\WIN\USB3.0\ directory.
4. Click **Next**. If the device driver is already installed, click **Cancel**. Follow the instructions on the screen until the installation is finished.

### Installing the ThinkPad monitor file for Windows 2000/XP/Vista/7

The ThinkPad monitor file for Windows 2000/XP/Vista/7 is in the following directory:  
C:\SWTOOLS\DRIVERS\MONITOR

**Note:** If you cannot find this directory on your hard disk drive or solid state drive, download the ThinkPad monitor file for Windows 2000/XP/Vista/7 from the ThinkPad Web site at:  
<http://www.lenovo.com/ThinkPadDrivers>

**Note:** Before you install this file, make sure that the correct video driver has been installed.

To install the correct video driver, do the following:

1. Right-click on the desktop, and click **Personalize**.
2. Click **Display** at the left.
3. Click **Change display settings**.
4. Click **Advanced Settings**.
5. Click the **Monitor** tab.
6. Click **Properties**.
7. Click the **Driver** tab.
8. Click **Update Driver**.
9. Select **Browse my computer for driver software**, and then click **Let me pick from a list of device drivers on my computer**.
10. Click **Have Disk**.

11. Specify path C:\SWTOOLS\DRIVERS\MONITOR to this monitor INF file. Then, click **Open**.
12. Click **OK**.
13. Confirm the correct display type, then click **Next**.
14. When installation completes, click **Close**.
15. Click **Close** to close the Display Properties window.
16. Click **OK** on the **Monitor** tab.
17. Click **OK** and close the Display Settings window.

### Installing other device drivers and software

The device drivers are provided in the C:\SWTOOLS\DRIVERS directory on your hard disk drive. You will also need to install application software, which is provided in the C:\SWTOOLS\APPS directory on your hard disk drive. To do this, refer to the instructions in “Reinstalling preinstalled applications and device drivers” on page 65.

**Note:** If you cannot find the Supplement files, device drivers, and application software you need on your hard disk drive, or if you want to receive updates and the latest information about them, go to <http://www.lenovo.com/ThinkPadDrivers>.

---

## ThinkPad Setup

Your computer comes with the ThinkPad Setup program to enable you to select various setup parameters.

To start ThinkPad Setup, do the following:

1. Turn on the computer. When the logo screen is displayed, press the F1 key. The ThinkPad Setup program main menu opens.

**Note:** If you have set a supervisor password, the ThinkPad Setup program main menu will be displayed after you enter the password. You can start ThinkPad Setup by pressing Enter instead of entering the supervisor password. However, you cannot change the parameters that are protected by the supervisor password. For more information, refer to “Using passwords” on page 49.

2. Use the cursor keys to move to an item you want to change. When the item is highlighted, press Enter. A submenu is displayed.
3. Change the items you wish to change. To change the value of an item, press the following keys:
  - F6 or the combination of Shift and + : Change to a higher value.
  - F5 or – : Change to a lower value.

If the item has a submenu, press Enter to display it.

4. Press Esc to exit from the submenu.
5. If you are on a nested submenu, press Esc repeatedly until you reach the ThinkPad Setup program main menu.

**Note:** If you need to restore the settings to their original state as of the time of purchase, press F9 to load the default settings. You also can select an option on the **Restart** submenu to load the default settings or discard the changes.

6. Select **Restart**. Move the cursor to the option you want for restarting your computer, then press **Enter**. Your computer restarts.

## Main menu

The **Main** menu is the first interface you see after you enter ThinkPad Setup. It displays the following configuration of your computer:

- **UEFI BIOS Version**
- **UEFI BIOS Date (Year-Month-Day)**
- **Embedded Controller Version**
- **Machine Type Model**
- **System-unit serial number**
- **System board serial number**
- **Asset Tag**
- **CPU Type**
- **CPU Speed**
- **Installed memory**
- **UUID**
- **MAC address (Internal LAN)**

## Config menu

If you need to change the configuration of your computer, select **Config** from the ThinkPad Setup menu.

The following table lists the **Config** menu items.

### Notes:

- Default values are in **boldface**. The default settings are already optimized for you. If you consider changing the computer configuration, proceed with extreme caution. Setting the configuration incorrectly might cause unexpected results.
- On each submenu, press the Enter key to show selectable options and select a desired option, or type desired values from the keyboard directly.
- Some items are displayed on the menu only if the computer supports the corresponding features.

Table 5. Config menu items

Menu item	Submenu item	Value	Comments
<b>Network</b>	Wake On LAN	<ul style="list-style-type: none"> <li>• Disabled</li> <li>• <b>AC only</b></li> <li>• AC and Battery</li> </ul>	<p>Enable the system to power on when the Ethernet controller receives a magic packet (a special network message).</p> <p>If you select <b>AC Only</b>, Wake on LAN is enabled only when the ac power adapter is attached.</p> <p>If you select <b>AC and Battery</b>, Wake on LAN is enabled with any power sources.</p> <p><b>Notes:</b></p> <ul style="list-style-type: none"> <li>• AC power is required with magic packet type Wake on LAN.</li> <li>• The Wake on LAN function does not</li> </ul>

Table 5. Config menu items (continued)

Menu item	Submenu item	Value	Comments
			work when a hard disk password is set.
	Ethernet LAN Option ROM (for <b>Legacy Only</b> boot mode or <b>Both</b> with <b>Legacy first</b> )	<ul style="list-style-type: none"> <li>• Disabled</li> <li>• <b>Enabled</b></li> </ul>	Load the Ethernet LAN Option ROM to enable startup from an integrated network device.
	UEFI IPv4 Network Stack (for <b>UEFI Only</b> boot mode or <b>Both</b> with <b>UEFI first</b> )	<ul style="list-style-type: none"> <li>• Disabled</li> <li>• <b>Enabled</b></li> </ul>	Enable or disable Internet Protocol Version 4 (IPv4) network stack for UEFI environment.
<b>USB</b>	USB UEFI BIOS Support	<ul style="list-style-type: none"> <li>• Disabled</li> <li>• <b>Enabled</b></li> </ul>	Enable or disable boot support for USB storage devices.
	Always On USB	<ul style="list-style-type: none"> <li>• Disabled</li> <li>• <b>Enabled</b></li> </ul>	If you select <b>Enabled</b> , the external USB devices can be charged through USB connectors even when the system is in low power mode (sleep, hibernate, or power-off).
	Always On USB Charge in off mode	<ul style="list-style-type: none"> <li>• <b>Disabled</b></li> <li>• Enabled</li> </ul>	<p>If you select <b>Enabled</b>, the Always On USB connector enables you to charge some devices, such as iPod, iPhone, and BlackBerry smartphones when the computer is turned off.</p> <p><b>Note:</b> If you want to charge these devices when your computer is turned off, you will need to open the Power Manager program and configure corresponding settings to enable the Always On USB connector function. For details about how to enable the Always On USB connector function, refer to the online help information system of the Power Manager program.</p>
	USB 3.0 Mode	<ul style="list-style-type: none"> <li>• Disabled</li> <li>• Enabled</li> <li>• <b>Auto</b></li> </ul>	<p>Set the USB 3.0 controller mode for the ports shared between USB 2.0 and USB 3.0 controllers.</p> <p>If you select <b>Auto</b>, it enables you to connect and route appropriate USB 3.0 or USB 2.0 connectors.</p> <p>If you select <b>Enabled</b>, it enables USB 3.0 mode</p>



Table 5. Config menu items (continued)

Menu item	Submenu item	Value	Comments
			and allows USB 3.0 to be supported in the operating system.  If you select <b>Disabled</b> , it disables and hides the USB 3.0 controller, and USB 3.0 connectors will work as USB 2.0 connectors.
<b>Keyboard/Mouse</b>	TrackPoint	<ul style="list-style-type: none"> <li>• Disabled</li> <li>• <b>Enabled</b></li> </ul>	Enable or disable the built-in TrackPoint pointing device.  <b>Note:</b> If you want to use an external mouse, select <b>Disabled</b> .
	Touch Pad	<ul style="list-style-type: none"> <li>• Disabled</li> <li>• <b>Enabled</b></li> </ul>	Enable or disable the built-in touch pad.  <b>Note:</b> If you want to use an external mouse, select <b>Disabled</b> .
	Fn and Ctrl Key swap	<ul style="list-style-type: none"> <li>• <b>Disabled</b></li> <li>• Enabled</li> </ul>	If you select <b>Enabled</b> , the Fn key works as the Ctrl key, and the Ctrl key works as the Fn key.  <b>Note:</b> Even when <b>Enabled</b> is selected, you need to press the Fn key to resume the computer from sleep mode to normal operation.
	Fn Key Lock	<ul style="list-style-type: none"> <li>• <b>Disabled</b></li> <li>• Enabled</li> </ul>	If you select <b>Enabled</b> , you can press the Fn key to keep it in a pressed condition, and then press the desired function key. The action is equivalent to pressing the Fn key and the desired function key simultaneously. If you press the Fn key twice, the Fn key is kept in a pressed condition until you press the Fn key again.
	Keyboard Illumination Control	<ul style="list-style-type: none"> <li>• ThinkLight Only</li> <li>• Keyboard backlight Only</li> <li>• <b>Both</b></li> </ul>	Enable the ThinkLight light feature, the keyboard backlight feature, or both. After you make a selection, you can activate the the corresponding feature(s) by pressing Fn+Space.

Table 5. Config menu items (continued)

Menu item	Submenu item	Value	Comments
<b>Display</b>	Boot Display Device	<ul style="list-style-type: none"> <li>• <b>ThinkPad LCD</b></li> <li>• Analog (VGA)</li> <li>• Digital on ThinkPad</li> <li>• Digital 1 on dock</li> <li>• Digital 2 on dock</li> </ul>	<p>Select the display device that is to be activated at boot time. This selection is effective for boot time, password prompt, and ThinkPad Setup.</p> <p><b>Digital on ThinkPad</b> is the Mini DisplayPort on your computer.</p> <p><b>Digital 1 on dock</b> and <b>Digital 2 on dock</b> are DisplayPort or DVI connectors on a docking station.</p>
<b>Power</b>	Intel SpeedStep® technology  (Intel SpeedStep mounted models only)	<ul style="list-style-type: none"> <li>• Disabled</li> <li>• <b>Enabled</b></li> </ul> <p>Mode for AC</p> <ul style="list-style-type: none"> <li>• <b>Maximum Performance</b></li> <li>• Battery Optimized</li> </ul> <p>Mode for Battery</p> <ul style="list-style-type: none"> <li>• Maximum Performance</li> <li>• <b>Battery Optimized</b></li> </ul>	<p>Select the mode of Intel SpeedStep technology at runtime.</p> <p><b>Maximum Performance:</b> Always highest speed</p> <p><b>Battery Optimized:</b> Always lowest speed</p> <p><b>Disabled:</b> No runtime support, lowest speed</p>
	Adaptive Thermal Management	<p>Scheme for AC</p> <ul style="list-style-type: none"> <li>• <b>Maximize Performance</b></li> <li>• Balanced</li> </ul> <p>Scheme for Battery</p> <ul style="list-style-type: none"> <li>• Maximize Performance</li> <li>• <b>Balanced</b></li> </ul>	<p>Select a thermal management scheme to use.</p> <p><b>Maximize Performance:</b> Reduce CPU throttling</p> <p><b>Balanced:</b> Balance sound, temperature, and performance</p> <p><b>Note:</b> Each scheme affects fan sound, temperature, and performance.</p>
	Optical Drive Speed	<ul style="list-style-type: none"> <li>• High Performance</li> <li>• <b>Normal</b></li> <li>• Silent</li> </ul>	<p>Set the speed of the optical drive to the desired performance.</p>
	CPU Power Management	<ul style="list-style-type: none"> <li>• Disabled</li> <li>• <b>Enabled</b></li> </ul>	<p>Enable or disable the power saving feature that stops the microprocessor clock automatically when there are no system activities. Normally, it is not necessary to change the setting.</p>

Table 5. Config menu items (continued)

Menu item	Submenu item	Value	Comments
	PCI Express Power Management	<ul style="list-style-type: none"> <li>Disabled</li> <li><b>Enabled</b></li> </ul>	Enable or disable a feature that automatically adjusts power management when there is no PCI Express activity. Normally, it is not necessary to change the setting.
	Express Card Speed	<ul style="list-style-type: none"> <li>Generation 1</li> <li><b>Automatic</b></li> </ul>	Set the transfer speed of the ExpressCard to the desired level of performance. The <b>Automatic</b> option enables the ExpressCard to specify the transfer speed it supports.
	Power On with AC Attach	<ul style="list-style-type: none"> <li><b>Disabled</b></li> <li>Enabled</li> </ul>	<p>Enable or disable a feature that powers on the system when the ac power adapter is attached.</p> <p>If you select <b>Enabled</b>, the system is powered on when the ac power adapter is attached. When the system is in hibernate state, the system resumes.</p> <p>If you select <b>Disabled</b>, the system is not powered on nor resumed when the ac power adapter is attached.</p>
	Intel (R) Rapid Start Technology	<ul style="list-style-type: none"> <li>Disabled</li> <li><b>Enabled</b></li> </ul> <p>Enter after:</p> <ul style="list-style-type: none"> <li>Immediately</li> <li>1 minute</li> <li>2 minutes</li> <li>5 minutes</li> <li>10 minutes</li> <li>15 minutes</li> <li>30 minutes</li> <li>1 hour</li> <li>2 hours</li> <li><b>3 hours</b></li> </ul>	<p>To use this feature, a special partition on the solid state drive is required.</p> <p>When enabled, you can enable the 30 Day Standby function through the Power Manager program. The function enables the computer to enter a lower power state after the specified time in sleep state. And it takes only seconds to resume normal operation.</p>

Table 5. Config menu items (continued)

Menu item	Submenu item	Value	Comments
<b>Beep and Alarm</b>	Password Beep	<ul style="list-style-type: none"> <li>• <b>Disabled</b></li> <li>• Enabled</li> </ul>	Enable this option to have a beep sound when the system is waiting for a power-on, hard disk, or supervisor password. Different beeps will sound when the entered password matches or does not match the configured password.
	Keyboard Beep	<ul style="list-style-type: none"> <li>• <b>Enabled</b></li> <li>• Disabled</li> </ul>	Enable or disable keyboard beep when unmanageable key combinations are pressed.
<b>Serial ATA (SATA)</b>	SATA Controller Mode Option	<ul style="list-style-type: none"> <li>• Compatibility</li> <li>• <b>AHCI</b></li> </ul>	Select SATA controller operation mode.
<b>CPU</b>	Core Multi-Processing	<ul style="list-style-type: none"> <li>• Disabled</li> <li>• <b>Enabled</b></li> </ul>	Enable or disable additional execution core units within a CPU.  <b>Note:</b> If you are using a computer with a single-core processor, this item is not available.
	Intel Hyper-Threading Technology	<ul style="list-style-type: none"> <li>• Disabled</li> <li>• <b>Enabled</b></li> </ul>	Enable or disable additional logical processors within a processor core.
<b>Intel AMT</b>	Intel AMT Control	<ul style="list-style-type: none"> <li>• Disabled</li> <li>• <b>Enabled</b></li> <li>• Permanently Disabled</li> </ul>	<p>If you select <b>Enabled</b>, Intel AMT (Active Management Technology) is configured and additional setup items are provided in MEBx (Management Engine BIOS Extension) Setup.</p> <p>If you select <b>Permanently Disabled</b>, you will never be able to enable it again. Be cautious when you want to use this option.</p> <p><b>Note:</b> You can enter the MEBx Setup menu by pressing the Ctrl+P key combination in the Startup Interrupt Menu window. To display the Startup Interrupt Menu window, press the black button or Enter key during the power-on self-test (POST).</p>
	CIRA Timeout	0-255  <b>Note:</b> The default value is 60 seconds.	Set the timeout option for CIRA connection to be established. 1 though 254 seconds are selectable.

Table 5. Config menu items (continued)

Menu item	Submenu item	Value	Comments
			<p>If you select <b>0</b>, use 60 seconds as the default timeout value.</p> <p>If you select <b>255</b>, the waiting time for establishing a connection is unlimited.</p>
	Console Type	<ul style="list-style-type: none"> <li>• PC-ANSI</li> <li>• VT100</li> <li>• <b>VT100+</b></li> <li>• VT-UTF8</li> </ul>	<p>Select the console type for AMT.</p> <p><b>Note:</b> This console type should match the Intel AMT remote console.</p>

## Date/Time menu

If you need to set the current date and time of your computer, select **Date/Time** from the ThinkPad Setup menu. The following submenu is displayed:

- System Date
- System Time

To change the date and time, do the following:

1. Using the up and down arrow keys to select the item to change the date or time.
2. Press Tab, Shift Tab, or Enter to select a field.
3. Type the date or time, or use the “-” and “+” keys to change the value.

## Security menu

If you need to set the security features of your computer, select **Security** from the ThinkPad Setup menu.

The following table lists the **Security** menu items.

### Notes:

- Default values are in **boldface**. The default settings are already optimized for you. If you consider changing the computer configuration, proceed with extreme caution. Setting the configuration incorrectly might cause unexpected results.
- On each submenu, press the Enter key to show selectable options and select a desired option, or type desired values from the keyboard directly.
- Some items are displayed on the menu only if the computer supports the corresponding features.

Table 6. Security menu items

Menu item	Submenu item	Value	Comments
<b>Password</b>	Hardware Password Manager	<ul style="list-style-type: none"> <li>• Disabled</li> <li>• <b>Enabled</b></li> </ul>	Manage your power-on password, supervisor password, and your hard disk passwords.
	Supervisor Password	<ul style="list-style-type: none"> <li>• <b>Disabled</b></li> <li>• Enabled</li> </ul>	See “Supervisor password” on page 52.
	Lock UEFI BIOS Settings	<ul style="list-style-type: none"> <li>• <b>Disabled</b></li> <li>• Enabled</li> </ul>	Enable or disable the function that protects items in ThinkPad Setup from being changed by a user who does not have the supervisor password. By default, this is set to <b>Disabled</b> . If you set the supervisor password and enable this function, no one but you can change any items in ThinkPad Setup.
	Password at unattended boot	<ul style="list-style-type: none"> <li>• Disabled</li> <li>• <b>Enabled</b></li> </ul>	If you select and enable <b>Password at unattended boot</b> , a password prompt is displayed when the computer is turned on, from either a power-off state or hibernation state, by an unattended event such as a Wake on LAN attempt. If you select <b>Disabled</b> , no password prompt is displayed; the computer goes ahead and loads the operating system. To prevent unauthorized access, set the user authentication on the operating system.
	Password at restart	<ul style="list-style-type: none"> <li>• <b>Disabled</b></li> <li>• Enabled</li> </ul>	If you select and enable <b>Password at restart</b> , a password prompt is displayed when you restart the computer. If you select <b>Disabled</b> , no password prompt is displayed; the computer goes ahead and loads the operating system. To prevent unauthorized access, set the user authentication on the operating system.
	Set Minimum Length	<ul style="list-style-type: none"> <li>• <b>Disabled</b></li> <li>• x characters (4≤x≤12)</li> </ul>	Specify a minimum length for power-on passwords and hard disk passwords. If you set the supervisor password and specify a minimum length for passwords, no one but you can change the length.
	Power-On Password	<ul style="list-style-type: none"> <li>• <b>Disabled</b></li> <li>• Enabled</li> </ul>	See “Power-on password” on page 50.
	Hard Disk x Password	<ul style="list-style-type: none"> <li>• <b>Disabled</b></li> <li>• Enabled</li> </ul>	See “Hard disk passwords” on page 50.  <b>Note:</b> <b>Hard Disk 1</b> means the hard disk drive built into your computer.
<b>Fingerprint</b>	Predesktop Authentication	<ul style="list-style-type: none"> <li>• Disabled</li> <li>• <b>Enabled</b></li> </ul>	Enable or disable fingerprint authentication before the operating system is loaded.
	Reader Priority	<ul style="list-style-type: none"> <li>• <b>External → Internal</b></li> <li>• Internal Only</li> </ul>	If <b>External → Internal</b> is selected, an external fingerprint reader is used if attached. Otherwise, an internal fingerprint reader is used. If <b>Internal Only</b> is selected, an internal fingerprint reader is used.
	Security Mode	<ul style="list-style-type: none"> <li>• <b>Normal</b></li> <li>• High</li> </ul>	If fingerprint authentication fails, you still can start the computer by entering a password. If you have selected <b>Normal</b> , enter a power-on password or a supervisor password; if you have selected <b>High</b> , enter a supervisor password.

Table 6. Security menu items (continued)

Menu item	Submenu item	Value	Comments
	Password Authentication	<ul style="list-style-type: none"> <li>Disabled</li> <li><b>Enabled</b></li> </ul>	Enable or disable password authentication. If high security mode is selected, this item is displayed.
	Reset Fingerprint Data	<ul style="list-style-type: none"> <li><b>Enter</b></li> </ul>	This option is used to erase all fingerprint data stored in the fingerprint reader and reset settings to the factory state. As a result, any power-on security features previously enabled will not be able to work until they are re-enabled in the fingerprint software.
<b>Security Chip</b>	Security Chip	<ul style="list-style-type: none"> <li>Active</li> <li><b>Inactive</b></li> <li>Disabled</li> </ul>	If you select <b>Active</b> , the security chip is functional. If you select <b>Inactive</b> , the <b>Security Chip</b> option is visible, but the security chip is not functional. If you select <b>Disabled</b> , the <b>Security Chip</b> option is hidden and the security chip is not functional.
	Security Reporting Options		Enable or disable the following Security Reporting Options: <ul style="list-style-type: none"> <li><b>BIOS ROM String Reporting:</b> BIOS text string</li> <li><b>ESCD Reporting:</b> Extended system configuration data</li> <li><b>CMOS Reporting:</b> CMOS data</li> <li><b>NVRAM Reporting:</b> Security data stored in the Asset ID</li> <li><b>SMBIOS Reporting:</b> SMBIOS data</li> </ul>
	Clear Security Chip	<ul style="list-style-type: none"> <li><b>Enter</b></li> </ul>	Clear the encryption key.  <b>Note:</b> This item is displayed only if you have selected <b>Active</b> for the <b>Security Chip</b> option.
	Intel TXT Feature	<ul style="list-style-type: none"> <li><b>Disabled</b></li> <li>Enabled</li> </ul>	Enable or disable Intel Trusted Execution Technology.
	Physical Presence for Provisioning	<ul style="list-style-type: none"> <li><b>Disabled</b></li> <li>Enabled</li> </ul>	This option enables or disables the confirmation message when you change the settings of the security chip.
	Physical Presence for Clear	<ul style="list-style-type: none"> <li>Disabled</li> <li><b>Enabled</b></li> </ul>	This option enables or disables the confirmation message when you clear the security chip.
<b>UEFI BIOS Update Option</b>	Flash UEFI Updating by End-Users	<ul style="list-style-type: none"> <li>Disabled</li> <li><b>Enabled</b></li> </ul>	If you select <b>Enabled</b> , all users can update the UEFI BIOS. If you select <b>Disabled</b> , only the person who knows the supervisor password can update the UEFI BIOS.
	Secure RollBack Prevention	<ul style="list-style-type: none"> <li><b>Disabled</b></li> <li>Enabled</li> </ul>	If you select <b>Disabled</b> , end-user can flash the older version UEFI BIOS. If you select <b>Enabled</b> , end-user cannot flash the older version UEFI BIOS.
<b>Memory Protection</b>	Execution Prevention	<ul style="list-style-type: none"> <li>Disabled</li> <li><b>Enabled</b></li> </ul>	Some computer viruses and worms cause memory buffers to overflow. By selecting <b>Enabled</b> you can protect your computer against attacks by such viruses and worms. If after choosing <b>Enabled</b> you find that an application program does not run correctly, select <b>Disabled</b> and reset the setting.

Table 6. Security menu items (continued)

Menu item	Submenu item	Value	Comments
<b>Virtualization</b>	Intel Virtualization Technology	<ul style="list-style-type: none"> <li>• Disabled</li> <li>• Enabled</li> </ul>	If you select <b>Enabled</b> , a Virtual Machine Monitor (VMM) can utilize the additional hardware capabilities provided by Intel Virtualization Technology.
	Intel VT-d Feature	<ul style="list-style-type: none"> <li>• Disabled</li> <li>• Enabled</li> </ul>	Intel VT-d stands for Intel Virtualization Technology for Directed I/O. When enabled, a VMM can utilize the platform infrastructure for I/O virtualization.
<b>I/O Port Access</b>	Ethernet LAN	<ul style="list-style-type: none"> <li>• Disabled</li> <li>• Enabled</li> </ul>	If you select <b>Enabled</b> , you can use the Ethernet LAN device.
	Wireless LAN	<ul style="list-style-type: none"> <li>• Disabled</li> <li>• Enabled</li> </ul>	If you select <b>Enabled</b> , you can use the Ethernet LAN connection.
	WiMAX	<ul style="list-style-type: none"> <li>• Disabled</li> <li>• Enabled</li> </ul>	If you select <b>Enabled</b> , you can use the WiMAX device.
	Wireless WAN	<ul style="list-style-type: none"> <li>• Disabled</li> <li>• Enabled</li> </ul>	If you select <b>Enabled</b> , you can use the wireless WAN device.
	Bluetooth	<ul style="list-style-type: none"> <li>• Disabled</li> <li>• Enabled</li> </ul>	If you select <b>Enabled</b> , you can use Bluetooth devices.
	USB Port	<ul style="list-style-type: none"> <li>• Disabled</li> <li>• Enabled</li> </ul>	If you select <b>Enabled</b> , you can use the USB connectors.
	ExpressCard Slot	<ul style="list-style-type: none"> <li>• Disabled</li> <li>• Enabled</li> </ul>	If you select <b>Enabled</b> , you can use the ExpressCard slot.
	Ultrabay (HDD/Optical)	<ul style="list-style-type: none"> <li>• Disabled</li> <li>• Enabled</li> </ul>	If you select <b>Enabled</b> , you can use external Ultrabay Enhanced devices.
	eSATA Port	<ul style="list-style-type: none"> <li>• Disabled</li> <li>• Enabled</li> </ul>	If you select <b>Enabled</b> , you can use the eSATA connector on the connected external device.
	Memory Card Slot	<ul style="list-style-type: none"> <li>• Disabled</li> <li>• Enabled</li> </ul>	If you select <b>Enabled</b> , you can use the memory card slots.
	Integrated Camera	<ul style="list-style-type: none"> <li>• Disabled</li> <li>• Enabled</li> </ul>	If you select <b>Enabled</b> , you can use the integrated camera.
	Microphone	<ul style="list-style-type: none"> <li>• Disabled</li> <li>• Enabled</li> </ul>	If you select <b>Enabled</b> , you can use the microphones (internal, external, or line-in).
Fingerprint Reader	<ul style="list-style-type: none"> <li>• Disabled</li> <li>• Enabled</li> </ul>	If you select <b>Enabled</b> , you can use the fingerprint reader.	



Table 6. Security menu items (continued)

Menu item	Submenu item	Value	Comments
<b>Anti-Theft</b>	Intel AT Module Activation	<ul style="list-style-type: none"> <li>• Disabled</li> <li>• <b>Enabled</b></li> <li>• Permanently Disabled</li> </ul>	<p>Enable or disable the UEFI BIOS interface to activate the Intel AT module, which is an optional anti-theft service from Intel.</p> <p><b>Note:</b> If you set the Intel AT module activation to <b>Permanently Disabled</b>, you will be unable to enable this setting again.</p>
	Intel AT Suspend	<ul style="list-style-type: none"> <li>• <b>Enter</b></li> </ul>	<p>This option is displayed only when the anti-theft function is activated.</p> <p>The Intel anti-theft suspend screen will be displayed at next boot to enter the suspend mode.</p>
	Computrace Module Activation	<ul style="list-style-type: none"> <li>• Disabled</li> <li>• <b>Enabled</b></li> <li>• Permanently Disabled</li> </ul>	<p>Enable or disable the UEFI BIOS interface to activate the computrace module. Computrace is an optional monitoring service from Absolute Software.</p> <p><b>Note:</b> If you set the computrace module activation to <b>Permanently Disabled</b>, you will be unable to enable this setting again.</p>

## Startup menu

To change the computer startup settings,, select **Startup** from the ThinkPad Setup main menu.

### Attention:

- After you change your startup sequence, you must be extremely careful not to specify a wrong device during a copy, a save, or a format operation. If you specify a wrong device, your data and programs might be erased or overwritten.
- If you are using the BitLocker drive encryption, you should not change the startup sequence. BitLocker drive encryption detects the change of startup sequence and locks the computer from booting.

### Changing the startup sequence

To change the startup sequence, do the following:

1. Select **Boot** or **Network**, then press Enter. The default boot list is displayed, showing the order in which devices will be started up. Even devices that are not attached to or installed on your computer are listed.
  - Use the **Boot** submenu to specify the startup sequence that runs when you turn on the power.
  - Use the **Network** submenu to specify the startup sequence that runs when Wake on LAN is enabled. Wake on LAN is commonly used by LAN administrators in corporate networks to get remote access to your computer.
2. Set the startup sequence by using the following keys:
  - Use cursor keys to select a device.
  - Use F6 or the combination of Shift and + to move the device up to a higher priority.
  - Use F5 or – to move the device down to a lower priority.
  - Use the combination of Shift and ! to exclude or include a device.
3. Press F10 to save the changes and restart the system.

To change the startup sequence temporarily so that the system starts up from a different drive, do the following:

1. Turn off the computer.
2. Turn on the computer; then, while the ThinkPad logo is displayed, press F12.
3. Select the device you want to start first.

**Note:** The **Boot** menu will be displayed when the system cannot boot from any devices or the operating system cannot be found.

The following table lists the **Startup** menu items.

**Notes:**

- Default values are in **boldface**.
- On each submenu, press the Enter key to show selectable options and select a desired option.
- Some items are displayed on the menu only if the computer supports the corresponding features.

Table 7. Startup menu items

Menu item	Value	Comments
<b>Boot</b>		See “Changing the startup sequence” on page 119.
<b>Network Boot</b>		Select the boot device when the system wakes from LAN. If <b>Wake On LAN</b> is enabled, the network administrator can turn on all of the computers in a LAN remotely by use of network management software.
<b>UEFI/Legacy Boot</b>	<ul style="list-style-type: none"> <li>• <b>Both</b></li> <li>• UEFI Only</li> <li>• Legacy Only</li> </ul>	Select system boot capability. <ul style="list-style-type: none"> <li>• <b>Both:</b> The system will boot following the <b>UEFI/Legacy Boot Priority</b> setting.</li> <li>• <b>UEFI Only:</b> The system will boot from the UEFI enabled operating system.</li> <li>• <b>Legacy Only:</b> The system will boot from any operating system other than the UEFI enabled one.</li> </ul> <p><b>Note:</b> If you select <b>UEFI Only</b>, the system cannot boot from the bootable devices that do not have the UEFI enabled operating system.</p>
<b>UEFI/Legacy Boot Priority</b>	<ul style="list-style-type: none"> <li>• UEFI First</li> <li>• <b>Legacy First</b></li> </ul>	Select priority of boot options between UEFI and Legacy.
<b>Boot Mode</b>	<ul style="list-style-type: none"> <li>• <b>Quick</b></li> <li>• Diagnostics</li> </ul>	Screen during the POST: <ul style="list-style-type: none"> <li>• <b>Quick:</b> The ThinkPad Logo screen is displayed.</li> <li>• <b>Diagnostics:</b> Text messages are displayed.</li> </ul> <p><b>Note:</b> You also can enter <b>Diagnostic</b> mode by pressing Esc during the POST.</p>

Table 7. Startup menu items (continued)

Menu item	Value	Comments
Option Keys display	<ul style="list-style-type: none"> <li>• Disabled</li> <li>• <b>Enabled</b></li> </ul>	If you select <b>Disabled</b> , the “To interrupt normal startup, press Enter.” message is not displayed during the POST.
Boot Device List F12 Option	<ul style="list-style-type: none"> <li>• Disabled</li> <li>• <b>Enabled</b></li> </ul>	If you select <b>Enabled</b> , the F12 key is recognized and the Boot Menu window is displayed.
Boot Order Lock	<ul style="list-style-type: none"> <li>• <b>Disabled</b></li> <li>• Enabled</li> </ul>	If you select <b>Enabled</b> , the boot priority order is locked for your future use.

## Restart menu

If you need to close ThinkPad Setup and restart the system, select **Restart** from the ThinkPad Setup menu. The following submenu is displayed:

- **Exit Saving Changes:** Restart the system after saving the changes.
- **Exit Discarding Changes:** Restart the system without saving the changes.
- **Load Setup Defaults:** Load the default setting that was in effect at the time of purchase.
- **Discard Changes:** Discard the changes.
- **Save Changes:** Save the changes.

## Updating your system UEFI BIOS

The Unified Extensible Firmware Interface (UEFI) BIOS is a part of the system programs that make up the basic layer of software built into your computer. The UEFI BIOS translates the instructions from other software layers.

Your computer system board has a module called EEPROM, also referred to as flash memory. You can update the UEFI BIOS by starting your computer with a flash update optical disc or flash update application running in the Windows environment.

In some instances when you add software, hardware, or a device driver, you might be informed that you need to update your UEFI BIOS in order for the new addition to work properly.

To update your UEFI BIOS, go to the following Web site and follow the instructions on the screen:  
<http://www.lenovo.com/ThinkPadDrivers>

---

## Using system management

This section is intended primarily for network administrators.

Your computer is designed for manageability, so that you can redirect more of your resources to better meet your business objectives.

This manageability, or so called as Total Cost of Ownership (TCO), enables you to remotely operate client computers in the same way as you operate your own computer, such as turning on a client computer, formatting hard disk drive, and installing software.

Once the computer is configured and operational, you can manage it by use of software and manageability features already integrated into the client system and the network.

## System management

Read this topic to learn more about features of system management.

### Desktop Management Interface

The system UEFI BIOS of your computer supports an interface called System Management BIOS Reference Specification (SMBIOS) V2.6.1. SMBIOS provides information about the hardware components of your system. It is the responsibility of the BIOS to supply this database with information about itself and the devices on the system board. This specification documents the standards for getting access to this BIOS information.

### Preboot eXecution Environment

The Preboot eXecution Environment (PXE) technology makes your computer more manageable (it is PXE 2.1-compliant) by enabling it to boot (load an operating system or another executable image) from a server. Your computer supports the personal computer functions that PXE requires. For example, with the appropriate LAN card, your computer can be booted from the PXE server.

**Note:** The Remote Initial Program Load (RPL) function cannot be used with your computer.

### Wake on LAN

A network administrator can use Wake on LAN to turn on a computer from a management console.

When Wake on LAN is used with network management software, many functions, such as data transfer, software updates, and Flash updates of UEFI BIOS, can be performed remotely without remote attendance. This updating process can be done after normal working hours and on weekends, to save time and increase productivity. Users are not interrupted during normal working hours, and LAN traffic is kept to a minimum.

If a computer is turned on by the Wake on LAN function, the **Network Boot** sequence is used.

### Asset ID EEPROM

The Asset ID EEPROM contains information about the system, including its configuration and the serial numbers of key components. It also includes a number of blank fields in which you can record information about the end users in your network.

## Setting management features

To enable the network administrator to control your computer remotely, you must configure the network interface by setting the system-management features in the ThinkPad Setup program. You can configure the following functions in the program:

- Wake on LAN
- Network Boot sequence
- Flash update

If an administrator password (supervisor password) has been set, you will need to specify it when you start ThinkPad Setup to use these functions.

### Wake on LAN

When the Wake on LAN feature is enabled on a computer that is connected to a LAN, a network administrator can start the computer remotely from a management console, using remote network-management software.

When your computer is not under the network administrator's system management, you can disable Wake on LAN.

To enable or disable Wake on LAN, do the following:

1. Start ThinkPad Setup.
2. Select **Config**. The **Config** submenu is displayed.
3. Select **Network**. The **Network item** submenu is displayed.
4. For **Wake On LAN**, select one of the following: **AC Only**, **AC and Battery**, or **Disabled**.
5. Press F10 to save changes and exit.

### **Network Boot sequence**

When your computer is turned on remotely, the system will try to boot from the device that is specified in the **Network Boot** setting, and then follow the boot order list on the **Boot** menu.

To define a sequence, do the following:

1. On the ThinkPad Setup program menu, select **Startup**. The submenu is displayed.
2. Select **Network Boot** and press the Enter key. The boot device list is displayed.
3. Select a boot device from the list to make it as the top boot priority.
4. Press F10 to save changes and exit.

**Note:** If you want to initialize the setting to return to the default startup sequence, press F9. The default settings are automatically reloaded.

### **Flash update**

Your network administrator can remotely update the system programs on your computer from a management console. The following requirements must be met:

- Your computer must be started over the LAN.
- Your computer must be engaged in a Preboot eXecution Environment (PXE).
- Network-management software must be installed on the remote administrator's computer.



---

## Chapter 9. Preventing problems

An important part of owning a ThinkPad notebook computer is maintenance. With proper care, you can avoid common problems. The chapter provides information that can help you keep your computer running smoothly.

- “General tips for preventing problems” on page 125
- “Making sure device drivers are current” on page 126
- “Taking care of your computer” on page 127

---

### General tips for preventing problems

- If your computer is equipped with both a hard disk drive and an mSATA solid state drive, you are not recommended to use the mSATA solid state drive as a bootable device. The mSATA solid state drive is designed and developed for the “cache” function purpose only. If you use the mSATA solid state drive as a bootable device, its reliability is not guaranteed.
- Check the capacity of your hard disk drive from time to time. If the hard disk drive gets too full, the Windows operating system will slow down and might produce errors.  
To check the hard disk drive capacity, click **Start → Computer**.
- Empty your recycle bin on a regular basis.
- Use disk defragment tool regularly on your hard disk drive to improve data seek and read times.
- To free up disk space, uninstall unused application programs.

**Note:** You also might want to look for application program duplication or overlapping versions.

- Clean out your Inbox, Sent, and Trash folders from your e-mail client program.
- Back up your data at least once a week. If critical data is present, it is a good idea to perform a daily backup operation. Lenovo has many backup options available for your computer. Rewritable optical drives are available for most machines and are easily installed.
- Schedule system restore operations to take a system snapshot periodically. For more information about system restore, see Chapter 5 “Recovery overview” on page 61.
- Update device drivers and UEFI BIOS when needed.
- Profile your machine at <http://www.lenovo.com/support> to keep up to date with current drivers and revisions.
- Keep up to date for device drivers on other non-Lenovo hardware. You might want to read the device driver information release notes prior to updating for compatibility or known issues.
- Keep a log book. Entries might include major hardware or software changes, driver updates, minor issues you have experienced, and how you resolved the minor issues.
- If you ever need to run a recovery on your computer to return the preload onto the machine, the following tips might help along the way:
  - Remove all external devices such as the printer, keyboard, and so on.
  - Make sure that your battery is charged and that you have the ac power connected.
  - Boot into ThinkPad Setup and load the default settings.
  - Restart the computer and start the recovery operation.
  - If your computer uses discs as the recovery media, do not remove the disc from the drive until prompted to do so.

- For suspected hard disk drive issues, refer to “Diagnosing problems” on page 131 prior to calling the Customer Support Center. If your computer does not start up, download the files to create a bootable self-test media from the following Web site: <http://www.lenovo.com/hddtest>. Run the test and record any messages or error codes. If the test returns any failing error codes or messages, call the Customer Support Center with the codes or messages and the computer in front of you. A technician will assist you further.
- If required, you can find your country's Customer Support Center at the following Web address: <http://www.lenovo.com/support/phone>. When calling the Customer Support Center, make sure that you have your machine model type, serial number, and the computer in front of you. Also, if the computer is producing error codes, it is helpful to have the error screen on or the message written down.

---

## Making sure device drivers are current

Device drivers are programs that contain instructions for the operating system about how to operate or drive a certain piece of hardware. Each hardware component on your computer has its own specific driver. If you add a new component, the operating system needs to be instructed on how to operate that piece of hardware. After you install the driver, the operating system can recognize the hardware component and understand how to use it.

**Note:** Because drivers are programs, like any other file on your computer, they are susceptible to corruption and might not perform correctly if corruption occurs.

It is not always necessary to download the latest drivers. However, you should download the latest driver for a component if you notice poor performance from that component or if you added a new component. This might eliminate the driver as the potential cause of the problem.

### Getting the latest drivers from the Web site

You can download and install updated device drivers from the Lenovo Web site by doing the following:

1. Go to <http://www.lenovo.com/ThinkPadDrivers>.
2. Select the entry for your computer and then follow the instructions on the screen to install or update necessary software.

### Getting the latest drivers using System Update

The System Update program helps you keep the software on your system up-to-date. Update packages are stored on Lenovo servers and can be downloaded from the Lenovo Support Web site. Update packages can contain applications, device drivers, UEFI BIOS flashes, or software updates. When the System Update program connects to the Lenovo Support Web site, the System Update program automatically recognizes the machine type and model of your computer, the installed operating system, and the language of the operating system to determine what updates are available for your computer. The System Update program then displays a list of update packages and categorizes each update as critical, recommended, or optional to help you understand the importance. You have complete control of which updates to download and install. After you select the update packages you want, the System Update program automatically downloads and installs the updates without any further intervention from you.

The System Update program is preinstalled on your computer and is ready to run. The only prerequisite is an active Internet connection. You can start the program manually, or you can use the schedule feature to enable the program to search for updates automatically at specified intervals. You also can predefine scheduled updates to search by severity (critical updates, critical and recommended updates, or all updates) so the list you choose from contains only those update types that are of interest to you.

For more information about how to use the System Update program, refer to the help information system of the program.



---

## Taking care of your computer

Although your computer is designed to function reliably in normal work environments, you need to use common sense in handling it. By following these important tips, you will get the most use and enjoyment out of your computer.

### Be careful about where and how you work

- Store packing materials safely out of the reach of children to prevent the risk of suffocation from plastic bags.
- Keep your computer away from magnets, activated cellular phones, electrical appliances, or speakers (within 13 cm or 5 inches).
- Avoid subjecting your computer to extreme temperatures (below 5°C/41°F or above 35°C/95°F).
- Some appliances, such as certain portable desktop fans or air purifiers, can produce negative ions. If a computer is close to such an appliance, and is exposed for an extended time to air containing negative ions, it might become electrostatically charged. Such a charge might be discharged through your hands when you touch the keyboard or other parts of the computer, or through connectors on I/O devices connected to it. Even though this kind of electrostatic discharge (ESD) is the opposite of a discharge from your body or clothing to the computer, it poses the same risk of a computer malfunction.

Your computer is designed and manufactured to minimize any effects of electrostatic charge. An electrostatic charge above a certain limit, however, can increase the risk of ESD. Therefore, when using the computer close to an appliance that can produce negative ions, give special attention to the following:

- Avoid directly exposing your computer to the air from an appliance that can produce negative ions.
- Keep your computer and peripherals as far as possible from such an appliance.
- Wherever possible, ground your computer to facilitate safe electrostatic discharge.

**Note:** Not all such appliances cause a significant electrostatic charge.

### Be gentle with your computer

- Avoid placing any objects (including paper) between the display and the keyboard or the palm rest.
- Your computer display is designed to be opened and used at an angle slightly greater than 90 degrees. Do not open the display beyond 180 degrees, as this might damage the computer hinge.
- Do not turn your computer over while the ac power adapter is plugged in. This could break the adapter plug.

### Carry your computer properly

- Before moving your computer, be sure to remove any media, turn off attached devices, and disconnect cords and cables.
- When picking up your open computer, hold it by the bottom. Do not pick up or hold your computer by the display.

### Handle storage media and drives properly

- If your computer comes with an optical drive, do not touch the surface of a disc or the lens on the tray.
- Wait until you hear the CD or DVD click into the center pivot of the drive before closing the tray.
- On your computer, use only optical drives designed for use with the Serial Ultrabay Enhanced bay.

**Note:** You can install a 9.5-mm-thick Serial Ultrabay Slim device or a 12.7-mm-thick Serial Ultrabay Enhanced device in the Serial Ultrabay Enhanced bay.

- When installing the hard disk drive, solid state drive, or optical drive, follow the instructions shipped with your hardware, and apply pressure only where needed on the device.
- Turn off your computer if you are replacing the hard disk drive or solid state drive.
- When replacing the primary hard disk drive or solid state drive, reattach the cover of the drive slot.
- Store your external and removable hard disk drive or optical drives in the appropriate containers or packaging when they are not being used.
- Before you install any of the following devices, touch a metal table or a grounded metal object. This action reduces any static electricity from your body. The static electricity could damage the device.
  - Memory modules
  - Mini-PCI cards
  - ExpressCards
  - Smart cards
  - Memory cards, such as SD cards, SDHC cards, SDXC cards, and MultiMediaCards

**Note:** Not all listed devices are included in your computer.

This action reduces any static electricity from your body. The static electricity could damage the device.

- While transferring data to or from a flash media card, such as an SD card, do not put your computer into sleep or hibernation mode before the data transfer is complete; otherwise, your data could become damaged.

### **Take care in setting passwords**

- Remember your passwords. If you forget a supervisor or hard disk password, Lenovo will not reset it, and you might have to replace your system board, or hard disk drive or solid state drive.

### **Care for the fingerprint reader**

The following actions could damage the fingerprint reader or cause it not to work properly:

- Scratching the surface of the reader with a hard, pointed object.
- Scraping the surface of the reader with your fingernail or anything hard.
- Using or touching the reader with a dirty finger.

If you notice any of the following conditions, gently clean the surface of the reader with a dry, soft, lint-free cloth:

- The surface of the reader is dirty or stained.
- The surface of the reader is wet.
- The reader often fails to enroll or authenticate your fingerprint.

### **Be sure not to modify your computer**

- Only an authorized ThinkPad repair technician should disassemble and repair your computer.
- Do not modify or tape the latches to keep the display open or closed.

## **Cleaning the cover of your computer**

Occasionally clean your computer by doing the following:

1. Prepare a mixture of a gentle kitchen-use detergent (one that does not contain abrasive powder or strong chemicals such as acid or alkaline). Use 5 parts water to 1 part detergent.
2. Absorb the diluted detergent into a sponge.

3. Squeeze excess liquid from the sponge.
4. Wipe the cover with the sponge, using a circular motion and taking care not to let any excess liquid drip.
5. Wipe the surface to remove the detergent.
6. Rinse the sponge with clean running water.
7. Wipe the cover with the clean sponge.
8. Wipe the surface again with a dry, soft, lint-free cloth.
9. Wait for the surface to dry completely and remove any fibers from the cloth.

### **Cleaning your computer keyboard**

To clean the computer keyboard, do the following:

1. Apply some isopropyl rubbing alcohol to a soft, dust-free cloth.
2. Wipe each keytop surface with the cloth. Wipe the keys one by one; if you wipe several keys at a time, the cloth might hook onto an adjacent key and possibly damage it. Make sure that no liquid drips onto or between the keys.
3. Allow to dry.
4. To remove any crumbs or dust from beneath the keys, you can use a camera blower with a brush or cool air from a hair dryer.

**Note:** Avoid spraying cleaner directly onto the display or the keyboard.

### **Cleaning your computer display**

To clean the computer display, do the following:

1. Gently wipe the display with a dry, soft lint-free cloth. If you see a scratchlike mark on your display, it might be a stain transferred from the keyboard or the TrackPoint pointing stick when the cover was pressed from the outside.
2. Wipe or dust the stain gently with a soft, dry cloth.
3. If the stain remains, moisten a soft, lint-free cloth with water or a 50-50 mixture of isopropyl alcohol and water that does not contain impurities.
4. Wring out as much of the liquid as you can.
5. Wipe the display again; do not let any liquid drip into the computer.
6. Be sure to dry the display before closing it.



---

## Chapter 10. Troubleshooting computer problems

This chapter provides information on what to do if you experience a problem with your computer.

- “Diagnosing problems” on page 131
- “Troubleshooting” on page 131

---

### Diagnosing problems

If you experience problems with your computer, use the Lenovo Solution Center program as a starting point for solving them.

#### Notes:

- The Lenovo Solution Center program is available only on models preinstalled with the Windows 7 operating system. It also can be downloaded from <http://www.lenovo.com/diagnose>.
- If you are using other Windows operating system rather than Windows 7, go to <http://www.lenovo.com/diagnose> for the latest information on diagnostics for your computer.

The Lenovo Solution Center program enables you to troubleshoot and resolve computer problems. It combines diagnostic tests, system information collection, security status, and support information, along with hints and tips for maximum system performance.

When you are setting up your computer, the Lenovo Solution Center program prompts you to create recovery media, which you can use to restore the hard disk drive to the factory default state. For more information, see “Performing backup and recovery operations” on page 62.

To run the Lenovo Solution Center program on the Windows 7 operating system, see “Accessing ThinkVantage applications on the Windows 7 operating system” on page 13.

For additional information, refer to the Lenovo Solution Center help system.

**Note:** If you are unable to isolate and repair the problem yourself after running the program, save and print the log files created by the program. You will need the log files when you speak to a Lenovo technical support representative.

---

### Troubleshooting

If your computer has an error, it typically displays a message or an error code, or a beep sounds when you turn it on. When you experience a problem, refer to the corresponding sections in this topic to try to solve the problem by yourself.

#### Computer stops responding

**Print these instructions now and keep it with your computer for reference later.**

If your computer is completely unresponsive (you cannot use the UltraNav pointing device or the keyboard), do the following:

1. Press and hold the power button until the computer turns off. After the computer is turned off, restart by pressing the power button. If the computer does not turn on, continue with step 2.

**Note:** Do not remove the battery and the ac power adapter to reset the computer.

2. While the computer is turned off, remove all power sources from the computer (battery and the ac power adapter). Hold down the power button for 10 seconds. Plug in the ac power adapter while keeping the battery out of the computer. If the computer does not turn back on, continue with step 3.

**Note:** Once the computer starts up and enters the Windows environment, use the proper shutdown procedure to turn the computer off. Once the computer is off, reattach the battery and restart the computer. If the computer does not start with the battery reattached, remove the battery and again start with step 2. If the computer starts with ac power but does not start when the battery is attached, call the Customer Support Center for support.

3. While the computer is off, remove all sources of power (battery and the ac power adapter). Remove all external devices that are attached to your computer (keyboard, mouse, printer, scanner, and so on). Repeat step 2. If step 2 is unsuccessful, continue with step 4.

**Note:** The following steps involve removing static sensitive components from your computer. Make sure that you are properly grounded and remove all sources of power attached to the computer. If you are uncomfortable or unsure about removing components please call the Customer Support Center for assistance.

4. While the computer is off, remove all sources of power and external hardware. Remove any non-original memory module added to your computer. After removing the extra memory module and reseating the original memory module, repeat step 2. If the computer still does not turn on, consult the user manual for other customer-replaceable components that are attached to your computer.

If the computer still does not start up, call the Customer Support Center and a Customer Support Specialist will assist you.

## Spills on the keyboard

With a mobile computer, there are increased chances of spilling liquids on the keyboard. Because most liquids conduct electricity, liquid spilled on the keyboard could create numerous short circuits, potentially causing irreparable damage to your computer.

### If you spill something on your computer:

**Attention:** Be sure that no liquid creates a short circuit between you and the ac power adapter (if in use). Although you might lose some data or work by turning off the computer immediately, leaving the computer on might make your computer unusable.

1. Carefully unplug the ac power adapter immediately.
2. Turn off the computer immediately. If the computer does not turn off, remove the battery. The more quickly you stop the current from passing through the computer the more likely you will reduce damage from short circuits.
3. Wait until you are certain that all the liquid is dry before turning on your computer.

**Note:** If you want to replace your keyboard, purchase a new one.

## Error messages

- **Message:** 0177: Bad SVP data, stop POST task.  
**Solution:** Checksum of the supervisor password in the EEPROM is not correct. The system board should be replaced. Have the computer serviced.
- **Message:** 0183: Bad CRC of Security Settings in EFI Variable. Enter ThinkPad Setup.  
**Solution:** Checksum of the Security settings in the EFI Variable is not correct. Enter ThinkPad Setup to check security settings, Press F10 and then press Enter to restart the system. If you still have a problem, have the computer serviced.

- **Message:** 0187: EAIA data access error  
**Solution:** The access to EEPROM is failed. Have the computer serviced.
- **Message:** 0188: Invalid RFID Serialization Information Area  
**Solution:** The EEPROM checksum is not correct (block # 0 and 1). The system board should be replaced, and the box serial number needs to be reinstalled. Have the computer serviced.
- **Message:** 0189: Invalid RFID configuration information area  
**Solution:** The EEPROM checksum is not correct (block # 4 and 5). The system board should be replaced, and the UUID needs to be reinstalled. Have the computer serviced.
- **Message:** 0190: Critical low-battery error  
**Solution:** The computer turned off, because the battery is low. Connect the ac power adapter to the computer and charge the battery, or replace the battery with a fully charged one.
- **Message:** 0191: System Security - Invalid remote change requested  
**Solution:** The system configuration change has failed. Confirm the operation and try again. To clear the error, enter ThinkPad Setup.
- **Message:** 0199: System Security - Security password retry count exceeded.  
**Solution:** This message is displayed if you enter a wrong supervisor password more than three times. Confirm the supervisor password and try again. To clear the error, enter ThinkPad Setup.
- **Message:** 1802: Unauthorized network card is plugged in - Power off and remove the network card.  
**Solution:** The mini PCI Express network card is not supported on this computer. Remove it.
- **Message:** 1820: More than one external fingerprint readers are attached.  
**Solution:** Power off and remove all but the reader that you set up within your main operating system.
- **Message:** 2000: ThinkVantage Active Protection sensor diagnostics failed.  
**Solution:** ThinkVantage Active Protection sensor is not working correctly. Have the computer serviced.
- **Message:** 2100: Detection error on HDD0 (Main HDD)  
**Solution:** The hard disk is not working. Have the hard disk serviced.
- **Message:** 2101: Detection error on HDD1 (Ultrabay HDD)  
**Solution:** The hard disk is not working. Have the hard disk serviced.
- **Message:** 2102: Detection error on HDD2 (Mini SATA)  
**Solution:** The Mini SATA device is not working. Have the Mini SATA device serviced.
- **Message:** 2110: Read error on HDD0 (Main HDD)  
**Solution:** The hard disk is not working. Have the hard disk serviced.
- **Message:** 2111: Read error on HDD1 (Ultrabay HDD)  
**Solution:** The hard disk is not working. Have the hard disk serviced.
- **Message:** 2112: Read error on HDD2 (Mini SATA)  
**Solution:** The Mini SATA device is not working. Have the Mini SATA device serviced.
- **Message:** 2200: Machine Type and Serial Number are invalid.  
**Solution:** Machine Type and Serial Number are invalid. Have the computer serviced.
- **Message:** 2201: Machine UUID is invalid.  
**Solution:** Machine UUID is invalid. Have the computer serviced.
- **Message:** Fan error  
**Solution:** Cooling fan has failed. Shut down the computer immediately and have the computer serviced.
- **Message:** Thermal sensing error

**Solution:** The thermal sensor has problem. Shut down the computer immediately and have the computer serviced.

- **Message:** This system does not support batteries that are not genuine Lenovo made or authorized. The system will continue to boot, but may not charge unauthorized batteries. Press the ESC key to continue.  
**Attention:** Lenovo has no responsibility for the performance or safety of unauthorized batteries, and provides no warranties for failures or damage arising out of their use.

**Solution:** Replace the battery with the correct Lenovo battery for this system. If you still see the same error message, contact with Lenovo service to have the computer serviced.

- **Message:** The battery installed is not supported by this system and will not charge. Please replace the battery with the correct Lenovo battery for this system. Press the ESC key to continue.

**Solution:** Replace the battery with the correct Lenovo battery for this system. If you still see the same error message, contact with Lenovo service to have the computer serviced.

## Errors without messages

- **Problem:** My screen keeps blanking when I do not want it to.

**Solution:** You can disable any system timers, such as the LCD turn-off timer or the blank timer by doing the following:

1. Start Power Manager.
2. Click the **Power plan** tab, and then select **Maximum Performance** from the predefined power plans.

- **Problem:** When I turn on the computer, nothing is displayed on the screen and the computer does not beep while starting up.

**Note:** If you are not sure whether you heard any beeps, turn off the computer by pressing and holding the power button for four seconds or more. Turn it on and listen again.

**Solution:** Make sure that:

- The battery is installed correctly.
- The ac power adapter is connected to the computer and the power cord is plugged into a working electrical outlet.
- The computer is turned on. (Turn the power button on again for confirmation.)
- The brightness level of the screen is appropriately set.

If a power-on password is set:

- Press any key to display the prompt for the power-on password.
- Type the correct password and press Enter.

If these items are correctly set, and the screen remains blank, have the computer serviced.

- **Problem:** When I turn on the computer, only a white cursor is displayed on a blank screen.

**Solution:** If you have modified a partition on your hard disk drive by using partition software, information about that partition, or the master boot record might have been destroyed.

1. Turn off the computer, and then turn it on again.
2. If you still see only the cursor on the screen, do the following:
  - If you have used the partition software, examine the partition on the hard disk drive by using the software, and recover the partition if required.
  - Use either the Rescue and Recovery workspace or the recovery discs to restore the system to the factory state.

If the problem persists, have the computer serviced.



- **Problem:** My screen goes blank while the computer is on.  
**Solution:** Your screen saver or power management might have been enabled. Do either of the following:
  - Touch the TrackPoint pointing device or the touch pad, or press a key to exit the screen saver.
  - Press the power button to resume from sleep or hibernation.

## Beep errors

Table 8. Beep errors

Problem	Solution
One short beep, pause, three short beeps, pause, three more short beeps, and one short beep	Make sure that memory modules are installed correctly. If they are, and you still hear the beeps, have the computer serviced.
Three short beeps, pause, one short beep, pause, one more short beep, and three short beeps	PCI resource allocation failure. Power off the computer and remove the device from the ExpressCard Slot. If the beeps persist, have the computer serviced.
One long and two short beeps	The video function has a problem. Have the computer serviced.
Four cycles of four short beeps	Shut down the computer immediately and have the computer serviced.
Five short beeps	The system board has a problem. Have the computer serviced.

## Memory module problems

**Print these instructions now and keep it with your computer for reference later.**

If your memory module is not operating properly, check the following items:

1. Verify that the memory module is installed and seated correctly in your computer.  
It might be necessary to remove all added memory modules to test the computer with only the factory-installed memory modules, and then reinstall the memory module one at a time to ensure a proper connection. See “Replacing a memory module” on page 73.
2. Check for error messages during startup.  
Follow the appropriate corrective actions for power-on self-test (POST). See “Error messages” on page 132.
3. Verify that the latest UEFI for your model has been installed.
4. Verify the proper memory configuration and compatibility including the maximum memory size and the memory speed. See “Replacing a memory module” on page 73.
5. Run diagnostic programs. See “Diagnosing problems” on page 131.

## Networking problems

The following are the most common networking problems.

### Ethernet problems

- **Problem:** Your computer cannot connect to the network.  
**Solution:** Make sure that:
  - The cable is installed correctly.

The network cable must be securely connected both to the Ethernet connector of your computer and to the RJ45 connector of the hub. The maximum allowable distance from the computer to hub is 100 meters. If the cable is connected and the distance is within acceptable limits but the problem persists, try a different cable.

- You are using the correct device driver. To install correct driver, do the following:
  1. Click **Start → Control Panel → Hardware and Sound → Device Manager**. If you are prompted for an administrator password or confirmation, type the password or provide confirmation.
  2. If the exclamation mark ! is displayed next to the adapter name under **Network adapters**, you might not be using the correct driver or the driver might have been disabled. To update the driver, right-click the highlighted adapter.
  3. Click **Update Driver Software**, and then follow the instructions on the screen.
- The switch port and the adapter have the same duplex setting.

If you configured the adapter for full duplex, make sure that the switch port also is configured for full duplex. Setting the wrong duplex mode can degrade performance, cause data loss, or result in lost connections.
- You have installed all networking software that is necessary for your network environment.

Check with your LAN administrator for the necessary networking software.

- **Problem:** The adapter stops working for no apparent reason.

**Solution:** The network driver files might be corrupt or missing. Update the driver by referring to the above solution for the procedure to make sure that the correct device driver is installed.

- **Problem:** If your computer is a Gigabit Ethernet model and you use a speed of 1000 Mbps, the connection fails or errors occur.**Solution:**

- Use Category 5 wiring and make sure that the network cable is securely connected.
- Connect to a 1000 BASE-T hub/switch (not 1000 BASE-X).

- **Problem:** The Wake on LAN feature is not working.

**Solution:** Make sure that Wake on LAN is enabled in ThinkPad Setup. If it is, check with your LAN administrator for the necessary settings.

- **Problem:** If your computer is a Gigabit Ethernet model, it cannot connect to the network at 1000 Mbps. Instead, it connects at 100 Mbps.

**Solution:**

- Try another cable.
- Make sure that the link partner is set to auto-negotiate.
- Make sure that the switch is 802.3ab-compliant (gigabit over copper).

## A wireless LAN problem

**Problem:** You cannot connect to the network using the built-in wireless network card.

**Solution:** Make sure that your wireless LAN driver is the latest version. Check the Web site and confirm that the driver version supported by the Access Connections program is the latest documented in the readme file.

Make sure that your computer is within range of a wireless access point.

Make sure that the wireless radio is enabled by double-clicking the Access Connections icon on the taskbar.

**Note:** If you are using the Windows 7 operating system, click the triangular icon on the taskbar to show hidden icons. The Access Connections icon is displayed. For more information about the icon, refer to the Access Connections help information system.

Check the Network Name (SSID) and your encryption information. Use the Access Connections program to verify this case-sensitive information.

## A wireless WAN problem

**Problem:** A message is displayed indicating that an unauthorized WAN card is installed.

**Solution:** The WAN card is not supported on this computer. Remove it.

**Note:** Depending on your computer, some models do not have a wireless WAN card.

## Bluetooth problems

**Note:** Check your connection anytime and make sure that no other Bluetooth-enabled device is searching for the device to which you want to connect. Simultaneous searching is not allowed in the Bluetooth connection.

- **Problem:** Sound does not come from the Bluetooth headset/headphone but comes from the local speaker even though the Bluetooth headset/headphone is connected using a Headset profile or AV profile.

**Solution:** Do the following:

1. Exit the application that uses the sound device (for example, Windows Media Player).
  2. Open Control Panel by clicking **Start → Control Panel → Hardware and Sound → Sound → Playback**.
  3. If you are using a Headset profile, select **Bluetooth Hands-free Audio** and click the **Set Default** button. If you are using an AV profile, select **Stereo Audio** and click the **Set Default** button.
  4. Click **OK** to close the Sound window.
- **Problem:** PIM items sent from the Windows 7 operating system cannot be received correctly into the address book of any other Bluetooth-enabled device.  
**Solution:** The Windows 7 operating system sends PIM items in XML format, but most Bluetooth-enabled devices handle PIM items in vCard format. If another Bluetooth-enabled device can receive a file through Bluetooth, a PIM item sent from the Windows 7 might be saved as a file with the extension .contact.

## Problems with the keyboard and other pointing devices

The following are the most common problems with keyboards and other pointing devices.

### UltraNav pointing device problems

- **Problem:** The pointer drifts when the computer is turned on or after it resumes normal operation.  
**Solution:** The pointer might drift when you are not using the TrackPoint pointing device during normal operation. This is a normal characteristic of the TrackPoint pointing device and is not a defect. Pointer drifting might occur for several seconds under the following conditions:
  - When the computer is turned on
  - When the computer resumes normal operation
  - When the TrackPoint pointing device is kept pressed for a long time
  - When the temperature changes
- **Problem:** The TrackPoint pointing device or touch pad does not work.  
**Solution:** Make sure that the TrackPoint pointing device or touch pad is enabled in the UltraNav Device Setting window.

### Keyboard problems

- **Problem:** All or some keys on the keyboard do not work.  
**Solution:** If an external numeric keypad is connected:

1. Turn off the computer.
2. Remove the external numeric keypad.
3. Turn on the computer and try using the keyboard again.

If the keyboard problem is resolved, carefully reconnect the external numeric keypad and the external keyboard. Make sure that you have seated the connectors correctly.

If the problem persists, make sure that the correct device driver is installed by doing the following:

1. Click **Start → Control Panel**. Change the view of Control Panel from Category to Large icons or Small icons.
2. Click **Keyboard**.
3. Select the **Hardware** tab. In the **Device Properties** pane, make sure that you see this message:  
Device Status: This device is working properly.

If keys on the keyboard still do not work, have the computer serviced.

- **Problem:** All or some keys on the external numeric keypad do not work.

**Solution:** Make sure that the external numeric keypad is correctly connected to the computer.

## Problems with the display and multimedia devices

This topic includes the most common problems with displays and multimedia devices, including the computer display, the external monitor, audio devices, and the optical drive.

### Computer screen problems

- **Problem:** The screen is blank.

**Solution:** Do the following:

- Press Fn+F7 to bring up the image.
- If you are using the ac power adapter, or using the battery and the battery status indicator is on (is green), press Fn+F9 to make the screen brighter.
- If the sleep status indicator is on (is green), press Fn to resume from the sleep mode.
- If the problem persists, follow the solution for the following problem.

- **Problem:** The screen is unreadable or distorted.

**Solution:** Make sure that:

- The display device driver is installed correctly.
- The screen resolution and color quality are correctly set.
- The monitor type is correct.

To check these settings, do the following:

1. Right-click on the desktop, and click **Personalize**.
2. Click **Display** at the left.
3. Select **Change display settings**. Check whether the screen resolution is correctly set.
4. Click **Advanced Settings**.
5. Click the **Adapter** tab.
6. Make sure that the correct device driver name is shown in the adapter information window.

**Note:** The device driver name depends on the video chip that has been installed on your computer.

7. Click the **Properties** button. If you are prompted for an administrator password or confirmation, type the password or provide confirmation. Check the **Device status** box and make sure that the device is working correctly. If not, click the **Troubleshoot** button and follow the instructions on the screen.

8. Click the **Monitor** tab. Check whether the color quality is correctly set, and make sure that the other information also is correct.
9. Click the **Properties** button. If you are prompted for an administrator password or confirmation, type the password or provide confirmation. Check the **Device status** box and make sure that the device is working correctly. If not, click the **Troubleshoot** button and follow the instructions on the screen.

- **Problem:** Incorrect characters are displayed on the screen.

**Solution:** Did you install the operating system or application program correctly? If they are installed and configured correctly, have the computer serviced.

- **Problem:** The screen stays on even after you turn off your computer.

**Solution:** Press and hold the power button for four seconds or more to turn off your computer; then turn it on again.

- **Problem:** Missing, discolored, or bright dots appear on the screen every time you turn on your computer.

**Solution:** This is an intrinsic characteristic of the TFT technology. Your computer display contains multiple thin-film transistors (TFTs). A small number of missing, discolored, or bright dots on the screen might exist all the time.

## External monitor problems

- **Problem:** The external monitor is blank.

**Solution:** To bring up the image, press Fn+F7 and select the desired monitor. If the problem persists, do the following:

1. Connect the external monitor to another computer to make sure that it works.
2. Reconnect the external monitor to your computer.
3. Refer to the manual shipped with the external monitor to check the resolutions and refresh rates that are supported.
  - If the external monitor supports the same resolution as the computer display or a higher resolution, view output on the external monitor or on both the external monitor and the computer display.
  - If the external monitor supports a lower resolution than the computer display, view output on the external monitor only. (If you view output on both the computer display and the external monitor, the external monitor screen will be blank or distorted.)

- **Problem:** You cannot set a higher resolution than the present one on your external monitor.

**Solution:** Make sure that the monitor type and other information is correct. If necessary, update the monitor driver. See “Setting the external monitor type” on page 37.

- **Problem:** The screen is unreadable or distorted.

**Solution:** Make sure that:

- The monitor information is correct and the appropriate monitor type is selected. Refer to the solution to the above problem.
- Make sure that an appropriate refresh rate is selected by doing the following:
  1. Connect the external monitor to the monitor connector, and then connect the monitor to an electrical outlet.
  2. Turn on the external monitor and the computer.
  3. Right-click on the desktop, and click **Screen resolution**.

**Note:** If your computer cannot detect the external monitor, click the **Detect** button.

4. Click the icon for the desired monitor (the **Monitor-2** icon is for the external monitor).
5. Click **Advanced Settings**.
6. Click the **Monitor** tab.

7. Select the correct screen refresh rate.

- **Problem:** Wrong characters are displayed on the screen.

**Solution:** Did you follow the correct procedure when installing the operating system or application program? If you did, have the external monitor serviced.

- **Problem:** The Extend desktop function does not work.

**Solution:** Enable the Extend desktop function. See “Using the Extend desktop function” on page 39.

- **Problem:** If you use the Extend desktop function, you cannot set a higher resolution or higher refresh rate on the secondary display.

**Solution:** Change the resolution and the color depth to lower settings for the primary display. Refer to the solution to the above problem.

- **Problem:** Display switching does not work.

**Solution:** If you use the Extend desktop function, disable it, and change the display output location. If a DVD movie or a video clip is playing, stop the playback, close the application, and then change the display output location.

- **Problem:** The screen position on the external monitor is incorrect when that monitor is set for a high resolution.

**Solution:** Sometimes, when you use a high resolution such as 1600x1200, the image is shifted to left or right on the screen. To correct this, first make sure that your external monitor supports the display mode (the resolution and the refresh rate) that you have set. If it does not, set a display mode that the monitor supports. If it does support the display mode you have set, go to the setup menu for the monitor itself and adjust the settings there. Usually the external monitor has buttons for access to the setup menu. For details, see the documentation that comes with the monitor.

## Audio problems

- **Problem:** Wave or MIDI sound does not play correctly.

**Solution:** Make sure that the built-in audio device is configured correctly.

1. Click **Start → Control Panel**.
2. Click **Hardware and Sound**.
3. Click **Device Manager**. If you are prompted for an administrator password or confirmation, type the password or provide confirmation.
4. Double-click **Sound, video and game controllers**.
5. Make sure that the Realtek HD Audio driver is enabled and configured correctly:

- **Problem:** Sound does not come from a headphone or a speaker, or your computer cannot record sounds.

**Solution:** To switch from one device to another (for example, from a speaker to a headphone, or from an external microphone to a built-in microphone), do the following:

1. Click **Start → Control Panel → Hardware and Sound**.
2. Click the **Realtek HD Manager** icon.
3. Make sure that you are in MULTI-STREAM mode in the Audio Director window.
4. In the Volume Mixer window, select the device you want—for example, speakers.
5. Play any sound via a music program (for example, Windows Media Player). Make sure that sound comes from speakers now.
6. Then, if you would like to switch to a headphone, close the music program.
7. Go to the Volume Mixer window. Then select another device, which is now the headphone.

8. Play any sound via the music program. Make sure that sound comes from a headphone attached directly to the system.

For more information, refer to the help information system of **Realtek HD Manager**.

**Note:** In the Volume Mixer window of **Realtek HD Manager**, a check mark by the entry for a device, such as speakers for a playback device, or a built-in microphone for a recording device, shows that the device has been selected.

- **Problem:** Recordings made using the microphone input are not loud enough.

**Solution:** Make sure that the Microphone Boost function is turned on and set by doing the following:

1. Click **Start → Control Panel**.
2. Click **Hardware and Sound**.
3. Click **Sound**.
4. Click the **Recording** tab in the Sound window.
5. Select **Microphone**, and click the **Properties** button.
6. Click the **Levels** tab, and move the Microphone Boost slider upwards.
7. Click **OK**.

**Note:** For details about controlling volume, refer to your Windows online help.

- **Problem:** A volume or balance slider cannot be moved.

**Solution:** The slider might be grayed out. This means that its position is fixed by the hardware and cannot be changed.

- **Problem:** The volume sliders do not stay in place when some audio applications are used.

**Solution:** It is normal for the sliders to change position when certain sound applications are used. The applications are aware of the settings in the Volume Mixer window and are allowed to change the settings themselves. An example is the Windows Media Player. Usually the application has sliders available to control the sound from within the application.

- **Problem:** The balance slider cannot completely mute one channel.

**Solution:** The control is designed to compensate for minor differences in balance and does not completely mute either channel.

- **Problem:** The sound cannot be turned off completely even if you set the Master volume control at minimum.

**Solution:** You still can hear some sound even though you have set the Master volume control at minimum. To turn off the sound completely, go to the Master volume control and select **Mute speakers**.

- **Problem:** When you connect a headphone to your computer while playing sound, a speaker does not produce sound.

**Solution:** Once the headphone is attached, the streaming is automatically redirected to it. If you want to listen to sound from the speakers again, be sure to set those speakers as the default device. For details, refer to the help information system for Realtek HD Audio.

## Fingerprint reader problems

- **Problem:** The surface of the reader is dirty, stained, or wet.

**Solution:** Gently clean the surface of the reader with a dry, soft, lint-free cloth.

- **Problem:** The reader often fails to enroll or authenticate your fingerprint.

**Solution:** If the surface of the reader is dirty, stained, or wet, gently clean the surface of the reader with a dry, soft, lint-free cloth.

For tips on how to maintain the fingerprint reader, see “Using the fingerprint reader” on page 56.

## Battery and power problems

This topic contains instructions on troubleshooting battery and power problems.

### Battery problems

- **Problem:** The battery pack cannot be fully charged in the standard charge time when the computer is powered off.

**Solution:** The battery pack might be over-discharged. Do the following:

1. Turn off the computer.
2. Make sure that the over-discharged battery pack is in the computer.
3. Connect the ac power adapter to the computer and let it charge.

If a quick charger is available, use it to charge the over-discharged battery pack.

If the battery pack cannot be fully charged in 24 hours, use a new battery pack.

- **Problem:** Your computer shuts down before the battery status indicator shows empty, or your computer operates after the battery status indicator shows empty.

**Solution:** Discharge and recharge the battery pack.

- **Problem:** The operating time for a fully charged battery pack is short.

**Solution:** Discharge and recharge the battery pack. If your battery operating time is still short, use a new battery pack.

- **Problem:** The computer does not operate with a fully charged battery pack.

**Solution:** The surge protector in the battery pack might be active. Turn off the computer for one minute to reset the protector; then turn on the computer again.

- **Problem:** The battery pack cannot be charged.

**Solution:** You cannot charge the battery when it is too hot. If the battery feels hot, remove it from the computer and allow it to cool to room temperature. After it cools, reinstall it and recharge the battery. If it still cannot be charged, have it serviced.

This system does not support batteries that are not genuine Lenovo-made or authorized. The system will continue to boot, but may not charge unauthorized batteries.

**Attention:** Lenovo has no responsibility for the performance or safety of unauthorized batteries, and provides no warranties for failures or damage arising out of their use.

### An ac power adapter problem

**Problem:** The ac power adapter is connected to the computer and the working electrical outlet, but the power adapter (power plug) icon is not displayed on the taskbar. Also the ac power indicator does not light up.

**Solution:** Do the following:

1. Make sure that the connection of the ac power adapter is correct. For instructions on connecting the ac power adapter, see *Safety, Warranty, and Setup Guide* that comes with your computer.
2. If the connection of the ac power adapter is correct, turn off the computer, then disconnect the ac power adapter and remove the main battery.
3. Reinstall the battery and reconnect the ac power adapter, then turn on the computer.
4. If the power adapter icon still is not displayed on the taskbar and the ac power indicator does not light up, have the ac power adapter and your computer serviced.

**Note:** If you are using the Windows 7 operating system, to display the power adapter (power plug) icon, click the triangular icon on the taskbar.



## Power problems

Print these instructions now and keep it with your computer for reference later.

**If your computer is getting no power at all, check the following items:**

1. Verify the power button. Refer to “Status indicators” on page 7. The power button is illuminated whenever the computer is on.
2. Check all power connections. Remove any power strips and surge protectors to connect the ac power adapter directly to the ac power outlet.
3. Inspect the ac power adapter. Check for any physical damage, and make sure that the power cable is firmly attached to the adapter brick and the computer.
4. Verify the ac power source is working by attaching another device to the outlet.
5. Remove the computer from a ThinkPad UltraBase Series 3, or a ThinkPad port replicator or docking station. Refer to “ThinkPad UltraBase Series 3” on page 90 and “Detaching a ThinkPad port replicator or docking station” on page 103.
6. Remove all devices and then test for system power with minimal devices attached.
  - a. Disconnect the ac power adapter and all cables from the computer.
  - b. Close the computer display, and turn the computer over.
  - c. Remove the battery, memory module, hard disk drive or solid state drive. See Chapter 6 “Replacing devices” on page 67.
  - d. Wait for 30 seconds, and then reinstall the memory module and the known good battery or the ac power adapter to test the computer with minimal devices attached first.
  - e. Reinstall each device one at a time that you have removed in the earlier steps.

**If your computer does not run on battery power, check the following items:**

1. Remove and reseat the battery to make sure that it is properly connected. Refer to “Replacing the battery” on page 67.

2. Swap batteries with another similar model, if available.

If another similar ThinkPad model is available, then verify that the battery pack works in the other computer and that the battery pack for the other model works in this computer.

3. Verify the battery-status indicator. Refer to “Status indicators” on page 7.

The battery-status indicator is normally illuminated whenever the battery is installed and the computer is on, or the ac power adapter is connected and the battery is charging. This indicator may be blinking or solid in either orange or green color depending on the status of the battery.

## A power button problem

**Problem:** The system does not respond, and you cannot turn off the computer.

**Solution:** Turn off the computer by pressing and holding the power button for 4 seconds or more. If the system is still not reset, remove the ac power adapter and the battery.

## Startup problems

Print these instructions now and keep them with your computer for reference later.

If you receive an error message before the operating system loads, check the following item:

- If you receive an error message before the operating system loads, follow the appropriate corrective actions for power-on self-test (POST) error messages. See “Error messages” on page 132.

If you receive an error message while the operating system is loading the desktop configuration after the POST is completed, check the following items:

- Go to the Lenovo Support Web site at <http://www.lenovo.com/support> and search for the error message.
- Go to the Microsoft Knowledge Base homepage at <http://support.microsoft.com/> and search for the error message.

## Sleep and hibernation problems

- **Problem:** The computer enters sleep mode unexpectedly.

**Solution:** If the microprocessor overheats, the computer automatically enters sleep mode to allow the computer to cool and to protect the microprocessor and other internal components. Check the settings for sleep mode, using Power Manager.

- **Problem:** The computer enters sleep mode (the sleep indicator turns on) immediately after the power-on self-test.

**Solution:** Make sure that:

- The battery is charged.
- The operating temperature is within the acceptable range. Refer to “Operating environment” on page 13.

If the battery is charged and the temperature is within range, have the computer serviced.

- **Problem:** A critical low-battery error occurs, and the computer immediately turns off.

**Solution:** The battery power is getting low. Connect the ac power adapter to the computer and plug it into an electrical outlet, or replace the battery with a charged one.

- **Problem:** The computer display remains blank after you press Fn to return from sleep mode.

**Solution:** Check whether an external monitor was disconnected or turned off while the computer was in sleep mode. If you disconnected or turned off the external monitor, connect it or turn it on before resuming the computer from the sleep mode. When resuming the computer from the sleep mode without attaching the external monitor or turning it on, and the computer display remains blank, press Fn+F7 to bring up the computer display.

- **Problem:** The computer does not return from sleep mode, or the sleep indicator stays on and the computer does not work.

**Solution:** If the system does not return from sleep mode, it might have entered sleep or hibernation mode automatically because the battery is depleted. Check the sleep indicator.

- If the sleep indicator is on, your computer is in sleep mode. Connect the ac power adapter to the computer; then press Fn.
- If the sleep indicator is off, your computer is in hibernation mode or power-off state. Connect the ac power adapter to the computer; then press the power button to resume operation.

If the system still does not return from sleep mode, your system might stop responding and you might not be able to turn off the computer. In this case, you need to reset the computer. If you have not saved your data, it might be lost. To reset the computer, press and hold the power button for 4 seconds or more. If the system is still not reset, remove the ac power adapter and the battery.

- **Problem:** Your computer does not enter sleep or hibernation mode.

**Solution:** Check whether any option has been selected to disable your computer from entering sleep or hibernation mode.

If your computer tries to enter sleep mode but the request is rejected, the device attached to the USB connector might have been disabled. If this occurs, do a hot-unplug-and-plug operation for the USB device.

- **Problem:** The battery discharges slightly while the computer is in hibernation mode.

**Solution:** If the wakeup function is enabled, the computer consumes small amount of power. This is not a defect. For details, refer to “Power-saving modes” on page 29.

## Problems with drives and other storage devices

This section includes hard disk drive problems and solid state drive problems.

### Hard disk drive problems

- **Problem:** The hard disk drive makes a rattling noise intermittently.

**Solution:** The rattling noise might be heard:

- When the hard disk drive begins or finishes getting access to data.
- When you carry the hard disk drive.
- When you carry your computer.

This is a normal characteristic of a hard disk drive and is not a defect.

- **Problem:** The hard disk drive does not work.

**Solution:** On the **Boot** menu of ThinkPad Setup, make sure that the hard disk drive is on the **Boot priority order** list. If it is on the **Excluded from boot order** list, it is disabled. Select the entry for it on the list and press Shift+1 to move it back to the **Boot priority order** list.

- **Problem:** After setting a hard disk password on the hard disk drive of the computer, you moved the drive to another computer. Now you cannot unlock the hard disk password.

**Solution:** Your computer supports an enhanced password algorithm. Computers older than yours might not support such a security function.

### A solid state drive problem

**Problem:** When you compress files or folders by use of the data compression function in Windows, and then decompress them, the process of writing to or reading from the files or folders is slow.

**Solution:** Apply the disk defragmentation tool in Windows for faster access to the data.

### A software problem

- **Problem:** An application does not run correctly.

**Solution:** Make sure that the problem is not being caused by the application.

Check that your computer has the minimum required memory to run the application. Refer to the manuals supplied with the application.

Check the following:

- The application is designed to operate with your operating system.
- Other applications run correctly on your computer.
- The necessary device drivers are installed.
- The application works when it is run on some other computer.

If an error message appears while you are using the application program, refer to the manuals supplied with the application.

If the application still does not run correctly, contact your place of purchase or a service representative for help.

## Problems with ports and connectors

The following are the most common problems with ports and connectors.

### A USB problem

**Problem:** A device connected to the USB connector does not work.

**Solution:** Open the Device Manager window. Make sure that the USB device setup is correct, and that the assignment of computer resource and the installation of the device driver are correct. To open the Device Manager window, click **Start → Control Panel → Hardware and Sound → Device Manager**. If you are prompted for an administrator password or confirmation, type the password or provide confirmation.

Refer to “Diagnosing problems” on page 131 for a diagnostic test of the USB connector.

### A docking station or port replicator problem

**Problem:** The computer does not start when you try to turn it on, and does not respond when you try to resume operation.

**Solution:** Make sure that:

- The ac power adapter is connected to the docking station or the port replicator.
- The indicator of the docking station is on.
- The computer is securely attached to the docking station or the port replicator.

---

## Chapter 11. Getting support

This chapter provides information about getting help and support from Lenovo.

- “Before you contact Lenovo” on page 147
- “Getting help and service” on page 147
- “Purchasing additional services” on page 149

---

### Before you contact Lenovo

Often, you can solve your computer problems by referring to the information in the explanations of error codes, running diagnostic programs, or by consulting the Lenovo Web site.

#### Registering your computer

Register your computer with Lenovo at <http://www.lenovo.com/register>. For more information, see “Registering your computer” on page 19.

#### Downloading system updates

Downloading updated software might resolve problems you experience with your computer.

To download updated software, go to the following Web site and follow the instructions on the screen:  
<http://www.lenovo.com/support>

#### Recording information

Before you talk to a Lenovo representative, record the following important information about your computer.

#### Recording problem symptoms and details

Collect the answers to the questions below before you call for help. Then, you will be able to get help as quickly as possible.

- What is the problem? Is it continuous or intermittent?
- Is there an error message? What is the error code, if any?
- What operating system are you using? Which version?
- Which software applications were running at the time of the problem?
- Can the problem be reproduced? If so, how?

#### Recording system information

The serial number label is on the bottom of your computer. Record the machine type and the serial number.

- What is the name of your Lenovo product?
- What is the machine type?
- What is the serial number?

---

### Getting help and service

If you need help, service, technical assistance, or just want more information about Lenovo products, you will find a wide variety of sources available from Lenovo to assist you. This section contains information

about where to go for additional information about Lenovo and our products, what to do if you experience a problem with your computer, and whom to call for service should it be necessary.

Information about your computer and preinstalled software, if any, is available in the documentation that comes with your computer. That documentation includes printed books, online books, readme files, and help files. In addition, information about Lenovo products is available on the World Wide Web.

Microsoft Service Packs are the latest software source for Windows product updates. They are available through Web download (connection charges might apply) or through disc. For more specific information and links, go to <http://www.microsoft.com>. Lenovo offers technical assistance with installation of, or questions related to, Service Packs for your Lenovo-preloaded Microsoft Windows product. For information, contact the Customer Support Center.

## Using diagnostic programs

Many computer problems can be solved without outside assistance. If you experience a problem with your computer, the first place to start is the troubleshooting information of your computer documentation. If you suspect a software problem, see the documentation, including readme files and help information systems, that comes with the operating system or application program.

ThinkPad notebook computers come with a set of diagnostic programs that you can use to help you identify hardware problems. See “Diagnosing problems” on page 131 for instructions on using the diagnostic programs.

The troubleshooting information or the diagnostic programs might tell you that you need additional or updated device drivers or other software. You can get the latest technical information and download device drivers and updates from the Lenovo Web site at <http://www.lenovo.com/support>.

## Lenovo support Web site

Technical support information is available on the Lenovo Support Web site at:  
<http://www.lenovo.com/support>

This Web site is updated with the latest support information such as the following:

- Drivers and software
- Diagnostic solutions
- Product and service warranty
- Product and parts details
- User guides and manuals
- Knowledge base and frequently asked questions

## Calling Lenovo

If you have tried to correct the problem yourself and still need help, during the warranty period, you can get help and information by telephone through the Customer Support Center. The following services are available during the warranty period:

- Problem determination - Trained personnel are available to assist you with determining if you have a hardware problem and deciding what action is necessary to fix the problem.
- Lenovo hardware repair - If the problem is determined to be caused by Lenovo hardware under warranty, trained service personnel are available to provide the applicable level of service.

- Engineering change management - Occasionally, there might be changes that are required after a product has been sold. Lenovo or your reseller, if authorized by Lenovo, will make selected Engineering Changes (ECs) that apply to your hardware available.

The following items are not covered:

- Replacement or use of parts not manufactured for or by Lenovo or nonwarranted parts

**Note:** All warranted parts contain a 7-character identification in the format FRU XXXXXXX.

- Identification of software problem sources
- Configuration of UEFI BIOS as part of an installation or upgrade
- Changes, modifications, or upgrades to device drivers
- Installation and maintenance of network operating systems (NOS)
- Installation and maintenance of application programs

For the terms and conditions of the Lenovo Limited Warranty that applies to your Lenovo hardware product, see “Warranty information” in the *Safety, Warranty, and Setup Guide* that comes with your computer.

If possible, be near your computer when you make your call in case the technical assistance representative needs to help you resolve a computer problem. Ensure that you have downloaded the most current drivers and system updates, run diagnostics, and recorded information before you call. When calling for technical assistance, have the following information available:

- Machine type and model
- Serial numbers of your computer, monitor, and other components, or your proof of purchase
- Description of the problem
- Exact wording of any error messages
- Hardware and software configuration information for your system

### Telephone numbers

For a list of the Lenovo Support phone numbers for your country or region, go to <http://www.lenovo.com/support/phone> or refer to the *Safety, Warranty, and Setup Guide* that comes with your computer.

**Note:** Phone numbers are subject to change without notice. The latest phone numbers are available at <http://www.lenovo.com/support/phone>. If the number for your country or region is not provided, contact your Lenovo reseller or Lenovo marketing representative.

---

## Purchasing additional services

During and after the warranty period, you can purchase additional services, such as support for Lenovo and non-Lenovo hardware, operating systems, and application programs; network setup and configuration services; upgraded or extended hardware repair services; and custom installations services. Service availability and service name might vary by country.

For more information about these services, go to:  
<http://www.lenovo.com/accessories/services/index.html>





---

## Appendix A. Regulatory Information

---

### Wireless related information

#### Wireless interoperability

Wireless LAN PCI Express Mini Card is designed to be interoperable with any wireless LAN product that is based on Direct Sequence Spread Spectrum (DSSS), Complementary Code Keying (CCK), and/or Orthogonal Frequency Division Multiplexing (OFDM) radio technology, and is compliant to:

- The 802.11b/g Standard, 802.11a/b/g or 802.11n draft 2.0 on Wireless LANs, as defined and approved by the Institute of Electrical and Electronics Engineers.
- The Wireless Fidelity (WiFi) certification as defined by the Wi-Fi Alliance.

Your Bluetooth card is compliant with Bluetooth Specification 4.0 as defined by the Bluetooth Special Interest Group SIG. It support the following profiles:

- Advanced Audio Distribution Profile (A2DP)
- Audio/Video Control Transport Protocol (AVCTP)
- Audio/Video Distribution Transport Protocol (AVDTP)
- A/V Remote Control Profile (AVRCP)
- Basic Imaging Profile (BIP)
- Basic Printing Profile (BPP)
- Dial-Up Networking Profile (DUN)
- File Transfer Profile (FTP)
- Generic Access Profile (GAP)
- Generic A/V Distribution Profile (GAVDP)
- Hardcopy Cable Replacement Profile (HCRP)
- Headset Profile (HSP)
- Hands-Free Profile (HFP)
- Human Interface Device Profile (HID)
- Message Access Profile (MAP)
- Object Exchange Protocol (OBEX)
- Object Push Profile (OPP)
- Personal Area Networking Profile (PAN)
- Phone Book Access Profile (PBAP)
- Service Discovery Protocol (SDP)
- Synchronization Profile (SYNC)
- Video Distribution Profile (VDP)
- Generic Attribute Profile (GATT)
- Proximity Profile
- Find Me Profile
- Immediate Alert Profile

- Battery Status Profile

### Usage environment and your health

Integrated wireless cards emit radio frequency electromagnetic energy like other radio devices. However, the level of energy emitted is far much less than the electromagnetic energy emitted by wireless devices like for example mobile phones.

Due to the fact that integrated wireless cards operate within the guidelines found in radio frequency safety standards and recommendations, Lenovo believes they are safe for use by consumers. These standards and recommendations reflect the consensus of the scientific community and result from deliberations of panels and committees of scientists who continually review and interpret the extensive research literature.

In some situation or environment, the use of integrated wireless cards might be restricted by the proprietor of the building or responsible representatives of the organization. These situations and areas might for example include:

- Using the integrated wireless cards on board of airplanes, in hospitals or near petrol stations, blasting areas (with electro-explosive devices), medical implants or body-worn electronic medical devices, such as pace makers.
- In any other environment where the risk of interference to other devices or services is perceived or identified as harmful.

If you are uncertain of the policy that applies to the use of wireless devices in a specific organization (such as airport or hospital), you are encouraged to ask for authorization to use integrated wireless cards prior to turning on the computer.

### Location of the UltraConnect™ wireless antennas

ThinkPad models feature an integrated diversity antenna system built into the display for optimal reception, enabling wireless communication wherever you are.

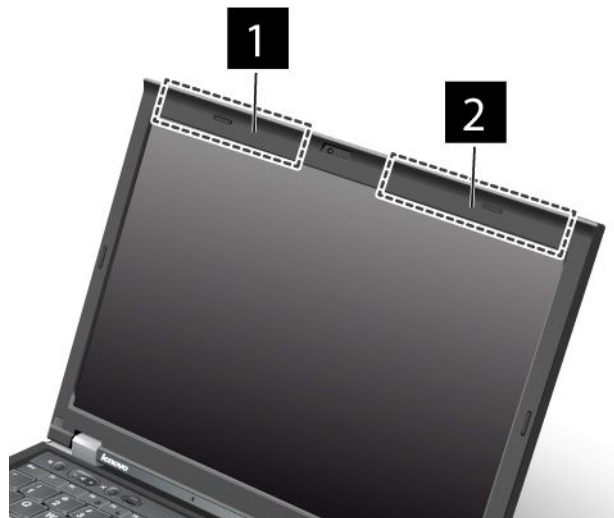

#### **1 Wireless LAN and WiMAX combo antenna (Auxiliary)**

The auxiliary antenna connected to the wireless LAN or WiMAX feature is located on the upper left side of the computer display, near the center.

#### **2 Wireless LAN (third), Wireless LAN/WiMAX (main), and Wireless WAN (main)**

The main antenna connected to the wireless LAN or WiMAX feature is located on the upper right side of the computer display, near the center. If your computer has the Multiple Input Multiple Output (MIMO) wireless LAN feature, the third wireless antenna also is located here.

## Locating wireless regulatory notices

For more information about the wireless regulatory notices, refer to the *Regulatory Notice* shipped with your computer.

If your computer is shipped without the *Regulatory Notice*, you can find it on the Web site at:  
<http://www.lenovo.com/ThinkPadUserGuides>

---

## Export classification notice

This product is subject to the United States Export Administration Regulations (EAR) and has an Export Classification Control Number (ECCN) of 4A994.b. It can be re-exported except to any of the embargoed countries in the EAR E1 country list.

---

## Electronic emission notices

The following information refers to ThinkPad X230 and X230i, machine type 2306, 2320, 2322, 2324, 2325, 2330, and 2333.

## Federal Communications Commission Declaration of Conformity

This equipment has been tested and found to comply with the limits for a Class B digital device, pursuant to Part 15 of the FCC Rules. These limits are designed to provide reasonable protection against harmful interference in a residential installation. This equipment generates, uses, and can radiate radio frequency energy and, if not installed and used in accordance with the instructions, might cause harmful interference to radio communications. However, there is no guarantee that interference will not occur in a particular installation. If this equipment does cause harmful interference to radio or television reception, which can be determined by turning the equipment off and on, the user is encouraged to try to correct the interference by one or more of the following measures:

- Reorient or relocate the receiving antenna.
- Increase the separation between the equipment and receiver.
- Connect the equipment into an outlet on a circuit different from that to which the receiver is connected.
- Consult an authorized dealer or service representative for help.

Lenovo is not responsible for any radio or television interference caused by using other than specified or recommended cables and connectors or by unauthorized changes or modifications to this equipment. Unauthorized changes or modifications could void the user's authority to operate the equipment.

This device complies with Part 15 of the FCC Rules. Operation is subject to the following two conditions: (1) this device may not cause harmful interference, and (2) this device must accept any interference received, including interference that may cause undesired operation.

Responsible Party:  
Lenovo (United States) Incorporated  
1009 Think Place - Building One  
Morrisville, NC 27560  
Phone Number: 919-294-5900



## Industry Canada Class B emission compliance statement

This Class B digital apparatus complies with Canadian ICES-003.

Cet appareil numérique de la classe B est conforme à la norme NMB-003 du Canada.

## European Union - Compliance to the Electromagnetic Compatibility Directive

This product is in conformity with the protection requirements of EU Council Directive 2004/108/EC on the approximation of the laws of the Member States relating to electromagnetic compatibility. Lenovo cannot accept responsibility for any failure to satisfy the protection requirements resulting from a non-recommended modification of the product, including the installation of option cards from other manufacturers.

This product has been tested and found to comply with the limits for Class B Information Technology Equipment according to European Standard EN 55022. The limits for Class B equipment were derived for typical residential environments to provide reasonable protection against interference with licensed communication devices.



## German Class B compliance statement

### Deutschsprachiger EU Hinweis:

#### Hinweis für Geräte der Klasse B EU-Richtlinie zur Elektromagnetischen Verträglichkeit

Dieses Produkt entspricht den Schutzanforderungen der EU-Richtlinie 2004/108/EG (früher 89/336/EWG) zur Angleichung der Rechtsvorschriften über die elektromagnetische Verträglichkeit in den EU-Mitgliedsstaaten und hält die Grenzwerte der EN 55022 Klasse B ein.

Um dieses sicherzustellen, sind die Geräte wie in den Handbüchern beschrieben zu installieren und zu betreiben. Des Weiteren dürfen auch nur von der Lenovo empfohlene Kabel angeschlossen werden. Lenovo übernimmt keine Verantwortung für die Einhaltung der Schutzanforderungen, wenn das Produkt ohne Zustimmung der Lenovo verändert bzw. wenn Erweiterungskomponenten von Fremdherstellern ohne Empfehlung der Lenovo gesteckt/eingebaut werden.

### Deutschland:

#### Einhaltung des Gesetzes über die elektromagnetische Verträglichkeit von Betriebsmitteln

Dieses Produkt entspricht dem „Gesetz über die elektromagnetische Verträglichkeit von Betriebsmitteln“ EMVG (früher „Gesetz über die elektromagnetische Verträglichkeit von Geräten“). Dies ist die Umsetzung der EU-Richtlinie 2004/108/EG (früher 89/336/EWG) in der Bundesrepublik Deutschland.

#### Zulassungsbescheinigung laut dem Deutschen Gesetz über die elektromagnetische Verträglichkeit von Betriebsmitteln, EMVG vom 20. Juli 2007 (früher Gesetz über die elektromagnetische Verträglichkeit von Geräten), bzw. der EMV EG Richtlinie 2004/108/EC (früher 89/336/EWG), für Geräte der Klasse B.

Dieses Gerät ist berechtigt, in Übereinstimmung mit dem Deutschen EMVG das EG-Konformitätszeichen - CE - zu führen. Verantwortlich für die Konformitätserklärung nach Paragraf 5 des EMVG ist die Lenovo (Deutschland) GmbH, Gropiusplatz 10, D-70563 Stuttgart.

Informationen in Hinsicht EMVG Paragraf 4 Abs. (1) 4:

**Das Gerät erfüllt die Schutzanforderungen nach EN 55024 und EN 55022 Klasse B.**

## Korea Class B compliance statement

B급 기기 (가정용 방송통신기자재)
이 기기는 가정용 (B급) 전자파적합기기로서 주로 가정에서 사용하는 것을 목적으로 하며, 모든 지역에서 사용할 수 있습니다

## Japan VCCI Class B compliance statement

この装置は、クラスB情報技術装置です。この装置は、家庭環境で使用することを目的としていますが、この装置がラジオやテレビジョン受信機に近接して使用されると、受信障害を引き起こすことがあります。  
取扱説明書に従って正しい取り扱いをして下さい。 VCCI-B

## Japan compliance statement for products which connect to the power mains with rated current less than or equal to 20 A per phase

日本の定格電流が 20A/相 以下の機器に対する高調波電流規制  
高調波電流規格 JIS C 61000-3-2 適合品

## Lenovo product service information for Taiwan

台灣 Lenovo 產品服務資訊如下：  
荷蘭商聯想股份有限公司台灣分公司  
台北市信義區信義路五段七號十九樓之一  
服務電話：0800-000-702



---

## Appendix B. WEEE and recycling statements

Lenovo encourages owners of information technology equipment to responsibly recycle their equipment when it is no longer needed. Lenovo offers a variety of programs and services to assist equipment owners in recycling their IT products. Information on product recycling offerings can be found on Lenovo's Internet site at [http://www.lenovo.com/social\\_responsibility/us/en/](http://www.lenovo.com/social_responsibility/us/en/).

---

### EU WEEE statements

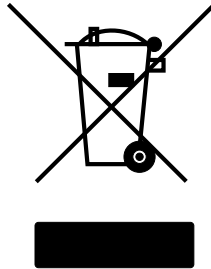

The Waste Electrical and Electronic Equipment (WEEE) mark applies only to countries within the European Union (EU) and Norway. Appliances are labeled in accordance with European Directive 2002/96/EC concerning waste electrical and electronic equipment (WEEE). The Directive determines the framework for the return and recycling of used appliances as applicable throughout the European Union. This label is applied to various products to indicate that the product is not to be thrown away, but rather reclaimed upon end of life per this Directive.

Users of electrical and electronic equipment (EEE) with the WEEE marking per Annex IV of the WEEE Directive must not dispose of end of life EEE as unsorted municipal waste, but use the collection framework available to them for the return, recycle, recovery of WEEE and minimize any potential effects of EEE on the environment and human health due to the presence of hazardous substances. For additional WEEE information go to: <http://www.lenovo.com/lenovo/environment>.

---

### Japan recycling statements

#### Collecting and recycling a disused Lenovo computer or monitor

If you are a company employee and need to dispose of a Lenovo computer or monitor that is the property of the company, you must do so in accordance with the Law for Promotion of Effective Utilization of Resources. Computers and monitors are categorized as industrial waste and should be properly disposed of by an industrial waste disposal contractor certified by a local government. In accordance with the Law for Promotion of Effective Utilization of Resources, Lenovo Japan provides, through its PC Collecting and Recycling Services, for the collecting, reuse, and recycling of disused computers and monitors. For details, visit the Lenovo Web site at: [http://www.lenovo.com/services\\_warranty/jp/ja/recycle/pcrecycle/](http://www.lenovo.com/services_warranty/jp/ja/recycle/pcrecycle/).

Pursuant to the Law for Promotion of Effective Utilization of Resources, the collecting and recycling of home-used computers and monitors by the manufacturer was begun on October 1, 2003. This service is provided free of charge for home-used computers sold after October 1, 2003. For details, go to [http://www.lenovo.com/services\\_warranty/jp/ja/recycle/personal/](http://www.lenovo.com/services_warranty/jp/ja/recycle/personal/).

## Disposing of Lenovo computer components

Some Lenovo computer products sold in Japan may have components that contain heavy metals or other environmental sensitive substances. To properly dispose of disused components, such as a printed circuit board or drive, use the methods described above for collecting and recycling a disused computer or monitor.

## Disposing of disused lithium batteries from Lenovo computers

A button-shaped lithium battery is installed on the system board of your Lenovo computer to provide power to the computer clock while the computer is off or disconnected from the main power source. If you want to replace it with a new one, contact your place of purchase or ask for a repair service provided by Lenovo. If you have replaced it by yourself and want to dispose of the disused lithium battery, insulate it with vinyl tape, contact your place of purchase, and follow their instructions. If you use a Lenovo computer at home and need to dispose of a lithium battery, you must comply with local ordinances and regulations.

## Disposing of disused battery packs from Lenovo notebook computers

Your Lenovo notebook computer has a lithium ion battery pack or a nickel metal hydride battery pack. If you are a company employee who uses a Lenovo notebook computer and need to dispose of a battery pack, contact the proper person in Lenovo sales, service, or marketing, and follow that person's instructions. You also can refer to the instructions at <http://www.lenovo.com/jp/ja/environment/recycle/battery/>. If you use a Lenovo notebook computer at home and need to dispose of a battery pack, you must comply with local ordinances and regulations. You also can refer to the instructions at <http://www.lenovo.com/jp/ja/environment/recycle/battery/>.

---

## Recycling information for Brazil

### Declarações de Reciclagem no Brasil

#### Descarte de um Produto Lenovo Fora de Uso

Equipamentos elétricos e eletrônicos não devem ser descartados em lixo comum, mas enviados à pontos de coleta, autorizados pelo fabricante do produto para que sejam encaminhados e processados por empresas especializadas no manuseio de resíduos industriais, devidamente certificadas pelos órgãos ambientais, de acordo com a legislação local.

A Lenovo possui um canal específico para auxiliá-lo no descarte desses produtos. Caso você possua um produto Lenovo em situação de descarte, ligue para o nosso SAC ou encaminhe um e-mail para: [reciclar@lenovo.com](mailto:reciclar@lenovo.com), informando o modelo, número de série e cidade, a fim de enviarmos as instruções para o correto descarte do seu produto Lenovo.

---

## Battery recycling information for Taiwan



廢電池請回收



---

## Battery recycling information for the European Union



**Notice:** This mark applies only to countries within the European Union (EU).

Batteries or packaging for batteries are labeled in accordance with European Directive 2006/66/EC concerning batteries and accumulators and waste batteries and accumulators. The Directive determines the framework for the return and recycling of used batteries and accumulators as applicable throughout the European Union. This label is applied to various batteries to indicate that the battery is not to be thrown away, but rather reclaimed upon end of life per this Directive.

In accordance with the European Directive 2006/66/EC, batteries and accumulators are labeled to indicate that they are to be collected separately and recycled at end of life. The label on the battery may also include a chemical symbol for the metal concerned in the battery (Pb for lead, Hg for mercury, and Cd for cadmium). Users of batteries and accumulators must not dispose of batteries and accumulators as unsorted municipal waste, but use the collection framework available to customers for the return, recycling, and treatment of batteries and accumulators. Customer participation is important to minimize any potential effects of batteries and accumulators on the environment and human health due to the potential presence of hazardous substances. For proper collection and treatment, go to:  
<http://www.lenovo.com/lenovo/environment>

---

## Battery recycling information for the United States and Canada



US & Canada Only



---

## Appendix C. ENERGY STAR model information



ENERGY STAR® is a joint program of the U.S. Environmental Protection Agency and the U.S. Department of Energy aimed at saving money and protecting the environment through energy efficient products and practices.

Lenovo is proud to offer our customers products with the ENERGY STAR qualified designation. Lenovo computers of the following machine types, if the ENERGY STAR mark is affixed, have been designed and tested to conform to the ENERGY STAR program requirements for computers.

2306, 2320, 2322, 2324, 2325, 2330, and 2333

By using ENERGY STAR qualified products and taking advantage of the power-management features of your computer, you can help reduce the consumption of electricity. Reduced electrical consumption can contribute to potential financial savings, a cleaner environment, and the reduction of greenhouse gas emissions.

For more information about ENERGY STAR, go to: <http://www.energystar.gov>

Lenovo encourages you to make efficient use of energy an integral part of your day-to-day operations. To help in this endeavor, Lenovo has preset the following power-management features to take effect when your computer has been inactive for a specified length of time:

**Power plan: Energy Saver (settings when plugged into ac power)**

- Turn off the display: After 10 minutes
- Put the computer into sleep: After 20 minutes
- Advanced power settings:
  - Turn off hard disks: After 15 minutes
  - Hibernate: Never

To awaken your computer from sleep mode, press the Fn key on your keyboard. For more information about these settings, see the Windows Help and Support information on your computer.

The Wake on LAN function is enabled when your Lenovo computer is shipped from the factory, and the setting remains valid even when the computer is in sleep mode. If you do not need to have Wake on LAN enabled while your computer is in sleep mode, you can reduce the power consumption and prolong the time in sleep mode, by disabling the setting of Wake on LAN for sleep mode. To disable the setting of Wake on LAN for sleep mode, do the following:

1. Click **Start** → **Control panel**.
2. Click **Hardware and Sound** → **Device Manager**.
3. In the Device Manager window, expand **Network adapters**.
4. Right-click your network adapter device, and click **Properties**.

5. Click the **Power Management** tab.
6. Clear the **Allow this device to wake the computer** check box.
7. Click **OK**.

---

## Appendix D. Notices

Lenovo may not offer the products, services, or features discussed in this document in all countries. Consult your local Lenovo representative for information on the products and services currently available in your area. Any reference to a Lenovo product, program, or service is not intended to state or imply that only that Lenovo product, program, or service may be used. Any functionally equivalent product, program, or service that does not infringe any Lenovo intellectual property right may be used instead. However, it is the user's responsibility to evaluate and verify the operation of any other product, program, or service.

Lenovo may have patents or pending patent applications covering subject matter described in this document. The furnishing of this document does not give you any license to these patents. You can send license inquiries, in writing, to:

*Lenovo (United States), Inc.  
1009 Think Place - Building One  
Morrisville, NC 27560  
U.S.A.  
Attention: Lenovo Director of Licensing*

LENOVO PROVIDES THIS PUBLICATION "AS IS" WITHOUT WARRANTY OF ANY KIND, EITHER EXPRESS OR IMPLIED, INCLUDING, BUT NOT LIMITED TO, THE IMPLIED WARRANTIES OF NON-INFRINGEMENT, MERCHANTABILITY OR FITNESS FOR A PARTICULAR PURPOSE. Some jurisdictions do not allow disclaimer of express or implied warranties in certain transactions, therefore, this statement may not apply to you.

This information could include technical inaccuracies or typographical errors. Changes are periodically made to the information herein; these changes will be incorporated in new editions of the publication. Lenovo may make improvements and/or changes in the product(s) and/or the program(s) described in this publication at any time without notice.

The products described in this document are not intended for use in implantation or other life support applications where malfunction may result in injury or death to persons. The information contained in this document does not affect or change Lenovo product specifications or warranties. Nothing in this document shall operate as an express or implied license or indemnity under the intellectual property rights of Lenovo or third parties. All information contained in this document was obtained in specific environments and is presented as an illustration. The result obtained in other operating environments may vary.

Lenovo may use or distribute any of the information you supply in any way it believes appropriate without incurring any obligation to you.

Any references in this publication to non-Lenovo Web sites are provided for convenience only and do not in any manner serve as an endorsement of those Web sites. The materials at those Web sites are not part of the materials for this Lenovo product, and use of those Web sites is at your own risk.

Any performance data contained herein was determined in a controlled environment. Therefore, the result obtained in other operating environments may vary significantly. Some measurements may have been made on development-level systems and there is no guarantee that these measurements will be the same on generally available systems. Furthermore, some measurements may have been estimated through extrapolation. Actual results may vary. Users of this document should verify the applicable data for their specific environment.

---

## Trademarks

The following terms are trademarks of Lenovo in the United States, other countries, or both:

- Lenovo
- Access Connections
- Active Protection System
- Rescue and Recovery
- Secure Data Disposal
- ThinkLight
- ThinkPad
- ThinkVantage
- TrackPoint
- Ultrabay
- Ultrabase
- UltraConnect
- UltraNav

Intel and Intel SpeedStep are trademarks or registered trademarks of Intel Corporation or its subsidiaries in the United States and other countries.

Microsoft, Windows, Bing, and BitLocker are trademarks of the Microsoft group of companies.

BlackBerry®, RIM®, Research In Motion®, SureType® and related trademarks, names and logos are the property of Research In Motion Limited and are registered and/or used in the U.S. and countries around the world. Used under license from Research In Motion Limited.

Other company, product, and service names may be trademarks or service marks of others.



**ThinkPad®**

Part Number:

Printed in China

(1P) P/N:



